

2020/2021

PDL & Clipsal Catalogue

Issue 73



pdl.co.nz

Life Is On



by Schneider Electric

This replaces all other editions. For pricing please refer to your electrical wholesaler.



Introducing the mySchneider app. The perfect partner for electricians.

Turn your phone into a powerful tool, to help you get the job done faster.



Access the Schneider Electric catalogue on your device to see our complete range of offers, including trade prices, FAQs, data sheets and more.



Connect to our customer care team, with live chat and other support services so you can get answers quickly and easily.



Save time with tools like built-in product barcode/QR code scanner which takes you straight to online product information.



Free access to Club Schneider, with the latest training information, product reviews and other exclusive club member benefits.

Download it now!



Designed for iOS and Android devices,
and is available in multiple languages.

Life Is On



by Schneider Electric



Our digital tools:

For Schneider Electric product information visit: se.com/nz

For PDL and Clipsal product information visit: pdl.co.nz

Register and sign up to our Partner Portal, for information relevant to you and your industry in one convenient location. For more information visit se.com/nz/partners



Join Club Schneider today, and put your feet up more often.



Looking to grow your business, expand your professional knowledge or want access to more tools to help you get the job done?

Club Schneider is a free program for all electricians in New Zealand, designed to save you time on site, and in the office. Whether you are just starting out on the tools or been in business for years, unlocking the benefits is simple and easy.

There are two ways you can instantly become a Club Member:

- 1 Scan the QR code to download the mySchneider app and complete the registration as an electrician.
- 2 Register as an electrician through the Partner Portal on the Schneider Electric website.

Sign up today, and start enjoying all the perks of being a part of Club Schneider.



pdl.co.nz/club

Scan to download the mySchneider app

Membership Benefits

	CLUB SILVER	CLUB GOLD
Sales Tools		
Free access to the mySchneider app, with features such as a digital product catalog, live chat with customer care and more	✓	✓
A printed copy of the PDL Pocketbook	✓	✓
Access free product displays		✓
Job management software partnership opportunity		✓
Your business listing featured on our Installer Locator		✓
Free product samples*	✓	✓
Entertainment		
Free invitation to Schneider Electric hosted networking and business education events	✓	✓
Gold Member event ticket access (sports events, concerts, trips and more)		✓
Private Club Facebook group invitation		✓
Education		
Free access to a range of online training	✓	✓
Option to become an EcoXpert for Home Automation, with special technical support and training		✓
Digital Schneider University	✓	✓
Influence product development by being invited to market research panels to test and/or give feedback on new products.		✓

Silver Membership is free to all Electricians in New Zealand, and able to be accessed through the mySE app or the Electrician Partner Portal. Gold Membership is available on application after fulfilling a loyalty criteria to Schneider Electric. For more information please talk to your Schneider Electric representative or refer to our website.

*Conditions apply. See our website for full membership terms, conditions and details.

Sign up today!

pdl.co.nz/club







Life Is On



by Schneider Electric

Contents

A Plate Ranges	
B General Wiring Accessories	
C Weather Protected Series	
D LED Lighting, Sensors & Smoke Alarms	
E Distribution Equipment	
F Ventilation	
G Data & Communications	
H Integrated Systems	

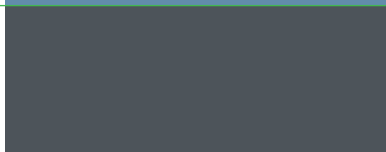
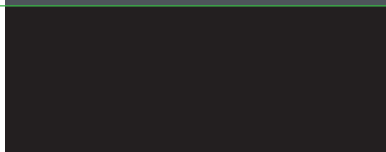
I	Electric Vehicle Charging	
J	Industrial Electrical Accessories	
K	Universal Enclosures	
L	Conduit Fittings, Flexible and Trunking	
M	Medical Electrical Equipment	
N	Powerguard RCD Protection	
O	Wiring Diagrams	
P	Alphanumeric Index	



Switch and Socket Plate Ranges



Contents

A3	PDL Iconic®	
A17	PDL Iconic® Essence	
A23	PDL Iconic® Styl	
A31	PDL Pro Series	
A39	PDL 600 Series	
A53	PDL Modules for 600 Series	
A61	Saturn Zen	
A65	Saturn Glass	
A69	Saturn Horizon	
A73	Metal Plate Series	
A77	Modules for Saturn Series (60 mech)	
A80	30 Series modules to suit Clipsal Plates	
A85	PDL Modena Series	
A90	PDL Modules for Modena 800 Series	

PDL Iconic™

A
Plate Ranges



Best Design Awards
Winner 2017



PDL Iconic® The next generation platform



PDL Iconic®
3

pdl.co.nz

PDL Iconic®

The new residential standard in electrical accessories that delivers clever efficiency to the home.

A stylish, modern range based on a slim, sleek, clean design. PDL's Iconic range features customisable skins and pictograms and blends in perfectly with any environment. Featuring innovative smart home functionality such as multi-way dimming, smart timers and dimmers, USB chargers and network connection points. Designed with electricians in mind, Iconic is easy to install and effortless to maintain.

PDL Iconic is available in four colours: Vivid White, Anthracite, Cool Grey, Warm Grey.



AN = Anthracite



VW = Vivid White



WY = Warm Grey



CY = Cool Grey



Bluetooth Low Energy

(BLE) connectivity

Simple configuration and control for lights, dimmers, or timers via the Wiser Room App on your phone or tablet.

24-hour timers, and 24-hour, 7 day scheduling time clocks program power to turn on at a time during the week and another on weekends e.g. for your heated towel rail in winter.

Switches, dimmers, and timers connect or pair point-to-point. There is no need for a router or hub or any special wiring. Connect with the Wiser app on your smart phone or tablet to setup or control these devices, or simply press the button on the switch to activate.





381-VV



381G



382-VV



382G



383-VV



383G



384-VV



384G

PDL Iconic®

Description	Ctn Qty	Item / CatNumber
Switch Plates		
1 Gang Switches, Grids and Skins		
Switch Plate 1G 20A/16AX 250V White	10	381-VV
Grid Plate Only 1 Gang (Less switch mech) Vertical or Horizontal	10	381G
Switch Skin Rocker 1G Anthracite	20	381C-AN
Switch Skin Rocker 1G Cool Grey	20	381C-CY
Switch Skin Rocker 1G White	20	381C-VV
Switch Skin Rocker 1G Warm grey	20	381C-WY
2 Gang Switches, Grids and Skins		
Switch Plate 2G 20A/16AX 250V White	10	382-VV
Grid Plate Only 2 Gang (Less switch mech) Vertical or Horizontal	10	382G
Switch Skin Rocker 2G Anthracite	20	382C-AN
Switch Skin Rocker 2G Cool Grey	20	382C-CY
Switch Skin Rocker 2G White	20	382C-VV
Switch Skin Rocker 2G Warm grey	20	382C-WY
3 Gang Switches, Grids and Skins		
Switch Plate 3G 20A/16AX 250V White	10	383-VV
Grid Plate Only 3 Gang (Less switch mech) Vertical or Horizontal	10	383G
Switch Skin Rocker 3G Anthracite	20	383C-AN
Switch Skin Rocker 3G Cool Grey	20	383C-CY
Switch Skin Rocker 3G White	20	383C-VV
Switch Skin Rocker 3G Warm grey	20	383C-WY
4 Gang Switches, Grids and Skins		
Switch plate 4G 20A/16AX 250V White	10	384-VV
Grid Plate Only 4 Gang (Less switch mech) Vertical or Horizontal	10	384G
Switch Skin Rocker 4G Anthracite	20	384C-AN
Switch Skin Rocker 4G Cool Grey	20	384C-CY
Switch Skin Rocker 4G White	20	384C-VV
Switch Skin Rocker 4G Warm grey	20	384C-WY

Description	Ctn Qty	Item / CatNumber
5 Gang, Grids and Skins		
Grid Plate Only 5 Gang (Less switch mech) Vertical or Horizontal	10	385G
Switch Skin Rocker 5G Anthracite	20	385C-AN
Switch Skin Rocker 5G Cool Grey	20	385C-CY
Switch Skin Rocker 5G White	20	385C-VW
Switch Skin Rocker 5G Warm grey	20	385C-WY
6 Gang, Grids and Skins		
Grid Plate Only 6 Gang (Less switch mech) Vertical or Horizontal	10	386G
Switch Skin Rocker 6G Anthracite	20	386C-AN
Switch Skin Rocker 6G Cool Grey	20	386C-CY
Switch Skin Rocker 6G White	20	386C-VW
Switch Skin Rocker 6G Warm grey	20	386C-WY
Switches and Accessories modules		
Switch Mech 2 Way 20A/16AX 250V	10	381M20
Switch Mech 2 Way 10AX 250V	10	381M10
Blank Dolly Rockers to suit 20 amp switches Packet of 10		
Blank Rockers Anthracite	10	381AR-AN
Blank Rockers Cool Grey	10	381AR-CY
Blank Rockers White	10	381AR-VW
Blank Rockers Warm Grey	10	381AR-WY
Printed Dolly Rockers to suit 20 amp switches Packet of 10 WHITE ONLY		
Printed Rockers Fan	10	381AFAN-VW
Printed Rockers Fridge	10	381AFRIDGE-VW
Printed Rockers Heat	10	381AHEAT-VW
Printed Rockers Hood	10	381AHOOD-VW
Printed Rockers Light	10	381ALIGHT-VW
Printed Rockers Microwave	10	381AMICROWWE-VW
Printed Rockers Outside	10	381AOUTSIDE-VW
Printed Rockers Sensor	10	381ASENSOR-VW
Printed Rockers Waste	10	381AWASTE-VW
Printed Rockers Auto Manual	10	381PAM-VW
Printed Rockers Dryer	10	381PDY-VW
Printed Rockers Hot Water	10	381PHW-VW
Printed Rockers On / off	10	381POF-VW



386C-VW



385G



386C-VW



386G



381M20



381R-AN



381R-CY



381R-VW



381R-WY



381AFAN-VW



381AHEAT-VW



381AFRIDGE-VW



381ALIGHT-VW



381PDY-VW

PDL Iconic®



378M10L



380M20DP



381M10PML-VW



380M32-VW



380R32-VW



381PHOB-VW



387M3T-VW



387A3T-VW



387M4R



40CSFM

Description	Ctn Qty	Item / CatNumber
Switches		
Switch Intermediate 10A 250V fitted with LED	10	378M10L
Switch 1 Way 20AX Double Pole	10	380M20DP
Switch Momentary		
Switch Spring Return 10A 250V fitted with LED Rocker Press	20	381M10PML-VW
Illumination for switches - LEDs		
LED kit 250V Warm White Packet 10	20	300ALED-W
32A Switch		
Switch 1 way 32A 250V	20	380M32-VW
Blank Dolly Rockers to suit 32 amp switches Packet of 10		
Packet of Blank Rockers Anthracite 32A	10	380AR32-AN
Packet of Blank Rockers Cool Grey 32A	10	380AR32-CY
Packet of Blank Rockers White 32A	10	380AR32-VW
Packet of Blank Rockers Warm Grey 32A	10	380AR32-WY
Printed Dolly Rockers to suit 32 amp switches Packet of 10 WHITE ONLY		
Packet of Printed Rockers Hob 32A	10	381PHOB-VW
Packet of Printed Rockers Oven 32A	10	381POVEN-VW
Packet of Printed Rockers Range 32A	10	381PRANGE-VW
Switches 3 position and printed Toggles		
Switch 3 Position Blank Rocker 10A 250V	20	387M3T-VW
Dolly Rocker 3pos Blank Anthracite	20	387A3T-AN
Dolly Rocker 3pos Blank Cool Grey	20	387A3T-CY
Dolly Rocker 3pos Blank White	20	387A3T-VW
Dolly Rocker 3pos Blank Warm Grey	20	387A3T-WY
3 set of 3 printed rockers SON- AOM-UOD- WHITE ONLY 9 printed rockers in total	20	387ALBLKIT-VW
Rotary Switches		
Rotary Switch 4 POS OFF 1 2 3 10A	20	387M4R
Dolly Rotary 4pos BLANK 4colour	20	387A4R
Rotary Fan Switch 0 1 2 3 10A	10	40CSFM

Description	Ctn Qty	Item / CatNumber
Latching Dolly Rockers to prevent accidental switching of a switch		
10 pack of Switch Latching Rockers	10	381ALR-AN
10 pack of Switch Latching Rockers	10	381ALR-CY
10 pack of Switch Latching Rockers	10	381ALR-VW
10 pack of Switch Latching Rockers	10	381ALR-WY
Dimmers		
Dimmer Mod Rotary LED 350W	6	354RDMLED-VW
Dimmer Mod Rotary Universal 350W	6	354RDMUN-VW
Dimmer Mod Push Button Universal with CTL	6	354PBDMUN-VW
Dimmer Mod Push Button with BLE & CTL	6	354PBDMTW-VW
Dimmer Knobs and Carriers		
Knob, Carrier & Knob Cap Vivid White	10	300KBC-VW
Knob, Carrier & Knob Cap Warm Grey	10	300KBC-WY
Knob, Carrier & Knob Cap Cool Grey	10	300KBC-CY
Knob, Carrier & Knob Cap Anthracite	10	300KBC-AN
Push Button Electronic		
Timer, Time Clock and Switch 10AX with BLE & CTL		356PB10MBTW-VW
Electronic SW 350W 2 Wire	6	356PBSM-VW
Secondary Switch for use with Primary CTL mechs	6	356PBSS-VW
Secondary Switch c/w LED Use with Primary CTL mechs		356PBSSL-VW
Push Button Colour Caps		
Pushbutton Mech Cap PK5 Vivid White	10	300PBC-VW
Pushbutton Mech Cap PK5 Warm Grey	10	300PBC-WY
Pushbutton Mech Cap PK5 Cool Grey	10	300PBC-CY
Pushbutton Mech Cap PK5 Anthracite	10	300PBC-AN



381ALR-VW



354RDMLED-VW



354PBDMUN-VW



300KBC-VW



356PBSM-VW



356PB10MBTW-VW



300PBC-VW



300PBC-AN



352MPIR



342USB-VW



342USB2-VW



300USBC-VW



300USBC-AN



300USBC2-VW



300USBC2-AN



334GC-VW

PDL Iconic®

Description	Ctn Qty	Item / CatNumber
Sensor		
PIR Motion Sensor Mech	6	352MPIR-TN
USB		
USB charging mechanism 1.5A shallow	6	342USB-VW
USB Dual charging mechanism 3.1 deep	6	342USB2-VW
USB Dual Charging Mechanism A + C		342USB2AC-VW
USB Colour Caps		
Single Port USB Cap PK5 Vivid White	10	300USBC-VW
Single Port USB Cap PK5 Warm Grey	10	300USBC-WY
Single Port USB Cap PK5 Cool Grey	10	300USBC-CY
Single Port USB Cap PK5 Anthracite	10	300USBC-AN
Dual Port USB Cap PK5 Vivid White	10	300USB2C-VW
Dual Port USB Cap PK5 Warm Grey	10	300USB2C-WY
Dual Port USB Cap PK5 Cool Grey	10	300USB2C-CY
Dual Port USB Cap PK5 Anthracite	10	300USB2C-AN
Dual Port USB A+C cap PK5 Vivid White	10	PDL300USB2CAC-VW
Dual Port USB A+C cap PK5 Warm Grey	10	PDL300USB2CAC-WY
Dual Port USB A+C cap PK5 Cool Grey	10	PDL300USB2CAC-CY
Dual Port USB A+C cap PK5 Anthracite	10	PDL300USB2CAC-AN
Grid and Cover plates - less Dolly Rockers		
Grid and Cover plate only 1 Gang (Less switch & Dolly Rocker)	20	331GC-VW *
Grid and Cover plate only 2 Gang (Less switch & Dolly Rocker)	20	332GC-VW *
Grid and Cover plate only 3 Gang (Less switch & Dolly Rocker)	20	333GC-VW *
Grid and Cover plate only 4 Gang (Less switch & Dolly Rocker)	20	334GC-VW *
Grid and Cover plate only 5 Gang (Less switch & Dolly Rocker)	15	335GC-VW *
Grid and Cover plate only 6 Gang (Less switch & Dolly Rocker)	15	336GC-VW *

* White only.

Description	Ctn Qty	Item / CatNumber
Data, Phone, RCA ,TV and HDMI Modules – for grid and cover plates		
Data modules		
Connector RJ45 Cat6	10	319MD-TN
Phone modules		
Telephone BT 2 wire Shutter	10	317M2-TN
TV module and plate		
TV PAL - F Type 1G Plate complete	10	328PF-VW
TV modules		
TV PAL - F Type	10	328MF-TN
TV F Type - F Type 3GHz	10	315MF-TN
HDMI and Audio modules		
HDMI Straight	10	315HDMI-TN
Audio Socket RCA RD+BK	10	340MRB-TN
Connector Banana Audio RD+BK	10	315MBBR-TN
Cable entry plate		
Cable entry Plate ONLY available in White	10	327CEP-VW
Dedicated plates		
USB		
USB Charge Grid only 3G 3x2.1A (4.5A max) 250V	10	343USBG
USB Shelf Skin Horiz 3G Anthracite	10	343HSC-AN
USB Shelf Skin Horiz 3G Cool Grey	10	343HSC-CY
USB Shelf Skin Horiz 3G White	10	343HSC-VW
USB Shelf Skin Horiz 3G Warm Grey	10	343HSC-WY
PCU		
Permanent Connection Unit & Switch 20A 16AX 250V White	10	351-VW
Module Permanent Connection Unit TN	10	351MPCU-TN



319MD-TN



328PF-VW



328MF-TN



315MF-TN



340MRB-TN



327CEP-VW



343USBG



343HSC-VW



351-VW



351MPCU-TN



347VHC



381VWP-VW



384VWP-VW



350C



361C-VW



300APP/100

PDL Iconic®

Description	Ctn Qty	Item / CatNumber
Oven / range switch		
Cooker Switch Double Pole 45A 250V white	10	347VH-VW
Cooker Switch Skin Double Pole 45A 250V Anthracite	20	347VHC-AN
Cooker Switch Skin Double Pole 45A 250V Cool Grey	20	347VHC-CY
Cooker Switch Skin Double Pole 45A 250V White	20	347VHC-WW
Cooker Switch Skin Double Pole 45A 250V Warm Grey	20	347VHC-WY
Water proof switches		
Switch IP44 1G 20A 250V White	10	381VWP-VW *
Switch IP44 2G 20A 250V White	10	382VWP-VW *
Switch IP44 3G 20A 250V White	10	383VWP-VW *
Switch IP44 4G 20A 250V White	10	384VWP-VW *
* ONLY available in White Dolly rockers used in VWP series are specific to water proof switches, are designed to minimise any damage/wear with the grids water proof membrane		
Blanking plate		
Blank Grid Plate Only VH	10	350G
Blank Plate Skin VH Anthracite	20	350C-AN
Blank Plate Skin VH Cool Grey	20	350C-CY
Blank Plate Skin VH White	20	350C-WW
Blank Plate Skin VH Warm Grey	20	350C-WY
Architrave plate		
Architrave Grid Plate Only 1G VH	20	361G
Architrave Skin Rocker 1G VH Anthracite	20	361C-AN
Architrave Skin Rocker 1G VH Cool Grey	20	361C-CY
Architrave Skin Rocker 1G VH White	20	361C-WW
Architrave Skin Rocker 1G VH Warm Grey	20	361C-WY
Architrave Grid Plate Only 2G VH	20	362G
Architrave Skin Rocker 2G VH Anthracite	20	362C-AN
Architrave Skin Rocker 2G VH Cool Grey	20	362C-CY
Architrave Skin Rocker 2G VH White	20	362C-WW
Architrave Skin Rocker 2G VH Warm Grey	20	362C-WY
Paint cover		
Protective Paint Cover Packet of 100	5	300APP/100

Description	Ctn Qty	Item / CatNumber
Sockets vertical		
Single Socket Vertical 10A 250V White	10	391-VW
Single Socket Vertical 10A 250V Grid Only	10	391G
Single Socket Vertical 10A Skin Only Anthracite	20	391C-AN
Single Socket Vertical 10A Skin Only Cool Grey	20	391C-CY
Single Socket Vertical 10A Skin Only White	20	391C-VW
Single Socket Vertical 10A Skin Only Warm Grey	20	391C-WY
Double Socket Vertical 10A 250V White	10	392-VW
Double Socket Vertical 10A 250V Grid Only also for use in 392	10	392XUAG
Double Socket Vertical 10A Skin Only Anthracite	20	392C-AN
Double Socket Vertical 10A Skin Only Cool Grey	20	392C-CY
Double Socket Vertical 10A Skin Only White	20	392C-VW
Double Socket Vertical 10A Skin Only Warm Grey	20	392C-WY
Double Socket Vertical 10A Extra switch fitted 20A White	10	392X-VW
Double Socket Vertical 10A Less Extra Switch Grid	10	392XUAG
Double Socket Vertical Skin Extra Switch Anthracite	20	392XC-AN
Double Socket Vertical Skin Extra Switch Cool Grey	20	392XC-CY
Double Socket Vertical Skin Extra Switch White	20	392XC-VW
Double Socket Vertical Skin Extra Switch Warm Grey	20	392XC-WY



391-VW



391G



391C-CY



391C-AN



392-VW



392XUAG



392XC-CY



392C-AN



392X-VW



392XUAG



392C-CY



392XC-AN

PDL Iconic®



394-VW



394G



394C-AN



394C-CY



394/15-VW



394/15G



394/15C-AN



394/15C-CY



394/20-VW



394/20G



394/20C-AN



394/20C-CY



394XUA-VW



394XUAG



394XC-AN



394XC-CY

Description	Ctn Qty	Item / CatNumber
Sockets Horizontal		
Single Socket Horizontal 10A 250V White	10	394-VW
Single Socket Horizontal 10A 250V Grid Only	10	394G
Single Socket Horizontal 10A Skin Only Anthracite	20	394C-AN
Single Socket Horizontal 10A Skin Only Cool Grey	20	394C-CY
Single Socket Horizontal 10A Skin Only White	20	394C-VW
Single Socket Horizontal 10A Skin Only Warm Grey	20	394C-WY
Single Socket Horizontal 15A 250V White	10	394/15-VW
Single Socket Horizontal 15A 250V Grid Only	10	394/15G
Single Socket Horizontal Skin 15A Anthracite	20	394/15C-AN
Single Socket Horizontal Skin 15A Cool Grey	20	394/15C-CY
Single Socket Horizontal Skin 15A White	20	394/15C-VW
Single Socket Horizontal Skin 15A Warm Grey	20	394/15C-WY
Single Socket Horizontal 20A 250V White	10	394/20-VW
Single Socket Horizontal 20A 250V Grid Only	10	394/20G
Single Socket Horizontal Skin 20A Anthracite	20	394/20C-AN
Single Socket Horizontal Skin 20A Cool Grey	20	394/20C-CY
Single Socket Horizontal Skin 20A White	20	394/20C-VW
Single Socket Horizontal Skin 20A Warm Grey	20	394/20C-WY
Single Socket Horizontal 10A Less Extra Switch White	10	394XUA-VW
Single Socket Horizontal 10A Less Extra Switch Grid	10	394XUAG
Single Socket Horizontal Skin Extra Switch Anthracite	20	394XC-AN
Single Socket Horizontal Skin Extra Switch Cool Grey	20	394XC-CY
Single Socket Horizontal Skin Extra Switch White	20	394XC-VW
Single Socket Horizontal Skin Extra Switch Warm Grey	20	394XC-WY

PDL Iconic®

Description	Ctn Qty	Item / CatNumber
Double Socket Horizontal 10A 250V White	10	395-VW
Double Socket Horizontal 10A 250V Grid Only	10	395G
Double Socket Horizontal Skin 10A Anthracite	20	395C-AN
Double Socket Horizontal Skin 10A Cool Grey	20	395C-CY
Double Socket Horizontal Skin 10A White	20	395C-VW
Double Socket Horizontal Skin 10A Warm Grey	20	395C-WY
Double Socket Horizontal 15A 250V White	10	395/15-VW
Double Socket Horizontal 15A 250V Grid Only	10	395/15G
Double Socket Horizontal Skin 15A Anthracite	20	395/15C-AN
Double Socket Horizontal Skin 15A Cool Grey	20	395/15C-CY
Double Socket Horizontal Skin 15A White	20	395/15C-VW
Double Socket Horizontal Skin 15A Warm Grey	20	395/15C-WY
Double Socket Horizontal 10A With Extra Switch 20A White	10	395X-VW
Double Socket Horizontal 10A Less Extra Switch Grid	10	395XUAG
Double Socket Horizontal Skin Extra Switch Anthracite	20	395XC-AN
Double Socket Horizontal Skin Extra Switch Cool Grey	20	395XC-CY
Double Socket Horizontal Skin Extra Switch White	20	395XC-VW
Double Socket Horizontal Skin Extra Switch Warm Grey	20	395XC-WY
Night walk sensor light		
Night walk sensor-light skin horiz VW	10	306-VW *
Night walk sensor-light skin horiz AN	10	306-AN *
Night walk sensor-light skin horiz CY	10	306-CY *
Night walk sensor-light skin horiz WY	10	306-WY *



* use with 395G



395USB-VW

392USB



395H4-VW



395H4XXUAG



395H4XXC-VW



395H4XXUAG



395H4XXC-AN



155H4



391RCD30-VW



395RCD30

PDL Iconic®

Description	Ctn Qty	Item / CatNumber
Double Sockets with USB		
Double Socket Horizontal 10A with Dual USB charging 3.1 Amp	5	395USB-VW
Double Socket Vertical 10A with Dual USB charging 3.1 Amp	5	392USB-VW
Quad Sockets Horizontal		
Quad Socket 10A 250V White	5	395H4-VW
Quad Socket 10A Less 2 x Extra Switch Grid Only also for use in 395H4XX	5	395H4XXUAG
Quad Socket Skin 10A Anthracite	10	395H4C-AN
Quad Socket Skin 10A Cool Grey	10	395H4C-CY
Quad Socket Skin 10A White	10	395H4C-VW
Quad Socket Skin 10A Warm Grey	10	395H4C-WY
Quad Socket Horizontal 10A Less 2 x Extra Switch White	5	395H4XXUA-VW
Quad Socket Horizontal 10A Less 2 x Extra Switch Grid Only	5	395H4XXUAG
Quad Socket Skin 10A Less 2 X Switch Anthracite	10	395H4XXC-AN
Quad Socket Skin 10A Less 2 X Switch Cool Grey	10	395H4XXC-CY
Quad Socket Skin 10A Less 2 X Switch White	10	395H4XXC-VW
Quad Socket Skin 10A Less 2 X Switch Warm Grey	10	395H4XXC-WY
Mounting Bracket H4 Quad Socket Horizontal	20	155H4
RCD Sockets 30mA		
Single Vertical Socket 10A RCD 30mA White	20	391RCD30-VW *
Single Vertical Socket Skin 10A RCD 30mA White	20	391RCD30C-VW *
Double Horizontal Socket 10A RCD 30mA White	20	395RCD30-VW *
Double Horizontal Socket 10A RCD 30mA White	20	395RCD30C-VW *

* White only.

Iconic Dolly Rocker Pictograms and Labels

32A

32A 380AR32	Range 380PRANGE	Oven 381POVEN	Hob 381PHOB	Kitchen 381PKITCHEN

20A and 10A

Hood 381AHOOD	Waste 381AWASTE	Microwave 381AMICROWAVE	Fridge 381AFRIDGE	Heat 381AHEAT	Fan 381AFAN
Light 381ALIGHT	Sensor 381ASENSOR	Outside 381AOUTSIDE	Hot Water 381AHW	Towel*	Dryer 381ADY
Sensor Off On 3POS (SON)	Auto Off Manual 3POS (AOM) 387ALBLKIT	Up Off Down 3POS (UOD)	On Off 381POF	Auto Manual 381PAM	*Dishwasher
x3 of each per pack					
*Air Conditioner	*Alarm	*TV	*Dining	*Study	*Family
*Bed 1	*Bed 2	*Bed 3	*Bed 4	*Bed	*Lounge
*Pump	*Spa	*Stairs	*Garden	*Washing Machine	

10A Press

*Press Line	*Press Bell icon

*Please refer to your local electrical wholesaler for these and any further marking requirements.



PDL Iconic® Essence Irrestibly timeless



PDL Iconic® Essence

PDL Iconic Essence is the newest set of skins from PDL to complement the Iconic range of electrical accessories.

Iconic Essence's new skin design simply clips onto standard Iconic grids, which means you only need to carry one base range of mechs and grids, and mix-and-match skin options to suit your customers' preferences

Irresistably timeless, PDL Iconic Essence is made with real birch timber and coated with matt lacquer to protect the timber and minimise reflections for a high quality finish.

Key features:

- Colour options: Arctic White, Ash Grey
- Finish: Smooth round wooden edges made from real birch timber
- Easy to change: Once your electrician has installed the Iconic platform, Iconic Essence skins can simply click on and off any Iconic standard grid, making style updates easier and simple
- Flexible: The new skin designs allows for all the major household solutions including switches, sockets and network connectivity using the existing Iconic platform and accessories
- Future-proof: Benefits from all the innovative Iconic platform technology, including Bluetooth Low Energy, Wiser Room App in-home control, Controllink, USB charging options, subtle LED indicators and more
- Matching accessories: Iconic Essence is colour matched with existing Iconic accessories for a polished finish.

Irresistibly timeless



(AW) Arctic White

(AG) Ash Grey

Colour Chart compatibility

Iconic Essence skins **Iconic Modules & Accessories**

AW Arctic White	VW Vivid White
AG Ash Grey	AG Ash Grey

Switches



E381C-AG



E381C-AW



E382C-AG



E382C-AW



E383C-AG



E383C-AW



E384C-AG



E384C-AW



E385C-AG



E385C-AW



E386C-AG



E386C-AW

Description	Ctn Qty	Item / CatNumber
Grid Vert/Horz 1G incl 10A Mech	10	381GM10
Skin Switch V/H 1G Rocker AG	10	E381C-AG
Skin Switch V/H 1G Rocker AW	10	E381C-AW
Grid Vert/Horz 2G incl 10A Mech	10	382GM10
Skin Switch V/H 2G Rocker AG	10	E382C-AG
Skin Switch V/H 2G Rocker AW	10	E382C-AW
Grid Vert/Horz 3G incl 10A Mech	10	383GM10
Skin Switch V/H 3G Rocker AG	10	E383C-AG
Skin Switch V/H 3G Rocker AW	10	E383C-AW
Grid Vert/Horz 4G incl 10A Mech	10	384GM10
Skin Switch V/H 4G Rocker AG	10	E384C-AG
Skin Switch V/H 4G Rocker AW	10	E384C-AW
Grid Vert/Horz 5G	10	385G
Skin Switch V/H 5G Rocker AG	10	E385C-AG
Skin Switch V/H 5G Rocker AW	10	E385C-AW
Grid Vert/Horz 6G	10	386G
Skin Switch V/H 6G Rocker AG	10	E386C-AG
Skin Switch V/H 6G Rocker AW	10	E386C-AW

Rockers, Rotary, Dimmers, Pushbuttons

Description	Ctn Qty	Item / CatNumber
Rockers		
Dolly Rocker BLANK PK 5 AG	5	E381AR-AG
Dolly Rocker BLANK PK 5 AW	5	E381AR-AW
Dolly Rocker 32A PK5 AG	5	E380AR32-AG
Dolly Rocker 32A PK5 AW	5	E380AR32-AW
Rotary		
Dolly Rocker 3Position PK5 AG	5	387A3T-AG
Dolly Rocker 3Position PK5 VW (use Iconic Vivid White)	5	387A3T-VW
Dimmer knob		
Kit Knob Dimmer AG	1	E300KBC-AG
Kit Knob Dimmer AW (use Iconic Vivid White)	1	300KBC-VW
Push button		
Dolly Pushbutton PK5 AG	5	E300PBC-AG
Dolly Pushbutton PK5 AW	5	E300PBC-AW
USB caps		
Carrier 1G USB Module Kit AG	5	300USBC-AG
Carrier 1G USB Module Kit VW (Use Iconic Vivid White)	5	300USBC-VW
Carrier 2G USB Module Kit AG	5	300USBC2-AG
Carrier 2G USB Module Kit VW (Use Iconic Vivid White)	5	300USBC2-VW
Carrier 2G USB A+C Module Kit AG	5	300USB2CAC-AG
Carrier 2G USB A+C Module Kit AW (Use Iconic Vivid White)	5	300USB2CAC-VW



E381AR-AG



E381AR-AW



387A3T-AG



387A3T-VW



E300KBC-AG



300KBC-VW



E300PBC-AG



300USBC-VW



300USBC-AG



300USBC-VW



300USBC2-AG



300USB2CAC-VW



343USBG



E343C-AG



E343C-AW



347VH-VW

Dedicated plates

Description	Ctn Qty	Item / CatNumber
3 Gang USB		
Grid 3 Gang USB	1	343USBG
Skin 3 gang USB charge station AW	1	E343C-AG
Skin 3 gang USB charge station AG	1	E343C-AW
Cooker Switch DP 45A		
Cooker Switch DP 45A 250V (remove VW Skin)	1	347VH-VW
Skin Switch V/H Cooker 45A AG	1	E347VHC-AG
Skin Switch V/H Cooker 45A AW	1	E347VHC-AW

Sockets

Description	Ctn Qty	Item / CatNumber
Double Vertical Socket Skin	1	E392C-AG
Double Vertical Socket Skin	1	E392C-AW
Double Vertical Socket X SW Skin	1	E392XC-AG
Double Vertical Socket X SW Skin	1	E392XC-AW
Skin Socket Sw Horiz Single AG	1	E394C-AG
Skin Socket Sw Horiz Single AW	1	E394C-AW
Skin Socket Sw Horiz Sgl 1ExSw AG	1	E394XC-AG
Skin Socket Sw Horiz Sgl 1ExSw AW	1	E394XC-AW
Skin Socket Sw Horiz Double AG	1	E395C-AG
Skin Socket Sw Horiz Double AW	1	E395C-AW
Skin Socket Sw Horiz Dbl 1ExSw AG	1	E395XC-AG
Skin Socket Sw Horiz Dbl 1ExSw AW	1	E395XC-AW
Skin Socket Sw Horiz Quad AG	1	E395H4C-AG
Skin Socket Sw Horiz Quad AW	1	E395H4C-AW
Skin Socket SwHorizQuad 2ExSw 10A250V AG	1	E395H4XXC-AG
Skin Socket SwHorizQuad 2ExSw 10A250V AW	1	E395H4XXC-AW



E394C-AG



E394C-AW



E394XC-AG



E394XC-AW



E392XC-AG



E392XC-AW



E395H4C-AG



E395H4C-AW



PDL Iconic® Styl Irresistibly beautiful



PDL Iconic® Styl

PDL Iconic Styl is the newest set of skins from PDL to complement the Iconic range of electrical accessories.

Iconic Styl's new skin design simply clips onto standard Iconic grids, which means you only need to carry one base range of mechs and grids, and mix-and-match skin options to suit your customers' preferences. It's simple efficiency that's sure to turn heads in any new build or renovation.

The Styl range is for home owners looking to achieve a modern and stylish interior design. It is available in three metallic shades and has a sharp, sophisticated appearance designed to suit any urban interior.

Key features:

- Anodised aluminium – sandblasted for a modern 'satin' appearance
- The flexibility of the new skin designs allows for all the major household solutions including switches, sockets and network connectivity
- Benefits from all the innovative Iconic platform technology, including Bluetooth Low Energy, ControlLink, USBs, mechs with LEDs and more
- Sophisticated and stylish, the new skins are available in three on-trend colours; Silver, Silver Shadow and Crowne

Irresistibly beautiful



(SV) Silver



(SH) Silver Shadow



(CE) Crowne

Colour Chart compatibility

Iconic Styl skins	Iconic Modules & Accessories
SV Silver	CY Cool Grey
SH Silver Shadow	AN Anthracite
CE Crowne	WY Warm Grey

Switches



S381C-SV



S381C-SH



S382C-SH



S382C-CE



S383GM10



S383C-SV



S384C-SV



S384C-SH



S385C-SH



S385C-CE



S386C-SV



S386C-CE

Description	Ctn Qty	Item / CatNumber
Grid Vert/Horiz 1G incl Mech 10A	10	381GM10
Skin Switch V/H 1G SV	10	S381C-SV
Skin Switch V/H 1G SH	10	S381C-SH
Skin Switch V/H 1G CE	10	S381C-CE
Grid Vert/Horiz 2G incl Mech 10A	10	382GM10
Skin Switch V/H 2G SV	10	S382C-SV
Skin Switch V/H 2G SH	10	S382C-SH
Skin Switch V/H 2G CE	10	S382C-CE
Grid Vert/Horiz 3G incl Mech 10A	10	383GM10
Skin Switch V/H 3G SV	10	S383C-SV
Skin Switch V/H 3G SH	10	S383C-SH
Skin Switch V/H 3G CE	10	S383C-CE
Grid Vert/Horiz 4G incl Mech 10A	10	384GM10
Skin Switch V/H 4G SV	10	S384C-SV
Skin Switch V/H 4G SH	10	S384C-SH
Skin Switch V/H 4G CE	10	S384C-CE
Grid Vert/Horiz 5G	10	385G
Skin Switch V/H 5G SV	10	S385C-SV
Skin Switch V/H 5G SH	10	S385C-SH
Skin Switch V/H 5G CE	10	S385C-CE
Grid Vert/Horiz 6G	10	386G
Skin Switch V/H 6G SV	10	S386C-SV
Skin Switch V/H 6G SH	10	S386C-SH
Skin Switch V/H 6G CE	10	S386C-CE

Grid only are less mechs

Use grid only + Iconic Styl skins (remove rockers) for Data/TV etc

PDL Iconic Styl skins are designed for use with PDL Iconic series product

Colour Chart compatibility

Iconic Styl skins

Iconic Modules & Accessories

SV Silver	CY Cool Grey
SH Silver Shadow	AN Anthracite
CE Crowne	WY Warm Grey

Rockers, Rotary, Dimmers, Pushbuttons

Description	Ctn Qty	Item / CatNumber
Dolly Rocker BLANK SV	5	S381AR-SV
Dolly Rocker BLANK SH	5	S381AR-SH
Dolly Rocker BLANK CE	5	S381AR-CE
<i>Use with PDL Iconic Mechs =<20A</i>		
Dolly Rocker 32A SV	5	S380AR32-SV
Dolly Rocker 32A SH	5	S380AR32-SH
Dolly Rocker 32A CE	5	S380AR32-CE
<i>Use with PDL Iconic Mechs 32A</i>		
Kit Knob Rotary OFF-1-2-3 SV	10	S387A4R-SV
Kit Knob Rotary OFF-1-2-3 SH	10	S387A4R-SH
Kit Knob Rotary OFF-1-2-3 CE	10	S387A4R-CE
Kit Knob Dimmer SV	10	S300KBC-SV
Kit Knob Dimmer SH	10	S300KBC-SH
Kit Knob Dimmer CE	10	S300KBC-SH
Dolly Pushbutton Universal SV	5	S300PBC-SV
Dolly Pushbutton Universal SH	5	S300PBC-SH
Dolly Pushbutton Universal CE	5	S300PBC-CE

Grid only are less mechs

Use grid only + Iconic Styl skins (remove rockers) for Data/TV etc

Dolly rocker pictos & labels - Refer Pg 23

PDL Iconic Styl skins are designed for use with PDL Iconic series product

Colour Chart compatibility

Iconic Styl skins	Iconic Modules & Accessories
SV Silver	CY Cool Grey
SH Silver Shadow	AN Anthracite
CE Crowne	WY Warm Grey



S381AR-SV



S381AR-SH



S380AR32-SH



S380AR32-CE



S387A4R-CE



S387A4R-SV



S300KBC-SV



S300KBC-SH



S300PBC-CE



S300PBC-SV



343USBG



S343C-SV



S343C-SH



S343C-CE



347VH-VW



S347C-SV



S347C-SH



S347C-CE

Dedicated Plates

Description	Ctn Qty	Item / CatNumber
USB Charge Grid only 3G 4.5A 250V	10	343USBG
Skin 3 gang USB charge station SV	10	S343C-SV
Skin 3 gang USB charge station SH	10	S343C-SH
Skin 3 gang USB charge station CE	10	S343C-CE
*Switch V/H Cooker DP 45A 250V	10	347VH-VW
Skin Switch V/H Cooker 45A SV	10	S347C-SV
Skin Switch V/H Cooker 45A SH	10	S347C-SH
Skin Switch V/H Cooker 45A CE	10	S347C-CE

PDL Iconic Styl skins are designed for use with PDL Iconic series product Colour Chart compatibility

Iconic Styl skins	Iconic Modules & Accessories
SV Silver	CY Cool Grey
SH Silver Shadow	AN Anthracite
CE Crowne	WY Warm Grey

Vertical Socket Skins

Description	Ctn Qty	Item / CatNumber
Double Vertical Socket Skin	10	S392C-CE
Double Vertical Socket Skin	10	S392C-SH
Double Vertical Socket Skin	10	S392C-SV
Add Double Vertical Grid 10	10	392G
Double Vertical Socket X SW Skin	10	S392XC-CE
Double Vertical Socket X SW Skin	10	S392XC-SH
Double Vertical Socket X SW Skin	10	S392XC-SV
Double Vertical Grid with xtra Switch	10	395XG



S392C-CE



S392C-SH



S392C-SV



S392XC-CE



S392XC-SH



S392XC-SV

Horizontal Sockets



S394C-SV

S394C-SH



S394XC-SH

S394XC-CE



S395C-CE

S395C-SV



S395XC-SV

S395XC-SH



S395H4C-SH



S395H4C-CE



S395H4XXC-SV

Description	Ctn Qty	Item / CatNumber
Grid Socket Horiz Single 10A 250V	10	394G
Skin Socket Sw Horiz Single SV	10	S394C-SV
Skin Socket Sw Horiz Single SH	10	S394C-SH
Skin Socket Sw Horiz Single CE	10	S394C-CE
Grid Socket Sw HorizSgl 1ExBlank 10A250V	10	394XUA
Skin Socket Sw Horiz Sgl 1ExSw SV	10	S394XC-SV
Skin Socket Sw Horiz Sgl 1ExSw SH	10	S394XC-SH
Skin Socket Sw Horiz Sgl 1ExSw CE	10	S394XC-CE
Grid Socket Sw Horiz Twin 10A 250V	10	395G
Skin Socket Sw Horiz Double SV	10	S395C-SV
Skin Socket Sw Horiz Double SH	10	S395C-SH
Skin Socket Sw Horiz Double CE	10	S395C-CE
Grid Socket SwHorizTwin 1ExBlank 10A250V	10	395XUAG
Skin Socket Sw Horiz Dbl 1ExSw SV	10	S395XC-SV
Skin Socket Sw Horiz Dbl 1ExSw SH	10	S395XC-SH
Skin Socket Sw Horiz Dbl 1ExSw CE	10	S395XC-CE
Grid Socket SwHorizQuad 2ExBlank10A250V	5	395H4XXUAG
Skin Socket Sw Horiz Quad SV	5	S395H4C-SV
Skin Socket Sw Horiz Quad SH	5	S395H4C-SH
Skin Socket Sw Horiz Quad CE	5	S395H4C-CE
Grid Socket SwHorizQuad 2ExBlank10A250V	5	395H4XXUAG
Skin Socket SwHorizQuad 2ExSw 10A250V SV	5	S395H4XXC-SV
Skin Socket SwHorizQuad 2ExSw 10A250V SH	5	S395H4XXC-SH
Skin Socket SwHorizQuad 2ExSw 10A250V CE	5	S395H4XXC-CE

Horizontal only

PDL Iconic Styl skins are designed for use with PDL Iconic series product Colour Chart compatibility

Iconic Styl skins

Iconic Modules & Accessories

SV Silver	CY Cool Grey
SH Silver Shadow	AN Anthracite
CE Crowne	WY Warm Grey

Iconic Styl Dolly Rocker Pictograms and Labels

32A



32A

*32A



* Range



* Oven



* Hob



* Kitchen

20A and 10A



* Hood



* Waste



* Microwave



* Fridge



* Heat



* Fan



* Light



* Sensor



* Outside



* Hot Water



* Towel



* Dryer



Sensor
Off
On



Auto
Off
Manual



Up
Off
Down



On
Off



Auto
Manual



*Dishwasher



*Air Conditioner



*Alarm



*TV



*Dining



*Study



*Family



*Bed 1



*Bed 2



*Bed 3



*Bed 4



*Bed



*Lounge



*Pump



*Spa



*Stairs



*Garden



*Washing Machine

10A Press



*Press Line



*Press Bell icon

***All PDL Iconic Styl rockers are marked locally through all wholesalers. Please refer to your local wholesaler for all Iconic Styl labelled dolly rocker needs.**



PDL Pro Series Raising the bar in commercial wiring devices



PDL Pro Series

PDL Pro Series is the first range of hard-wearing switches and sockets designed to meet the needs of commercial buildings.

Pro Series includes clever features such as permanent circuit identification with large integrated windows, available in black and white with a simple and functional design and extensive functionality including standard and electronic modules.

Key Features:

- Colour Options: Black and White
- Finish: Clean lines and bevelled edges
- Iconic advantages: Includes locking bar and fully compatible with 300 Series modules
- Circuit identification: Labels are protected behind a clear 9mm thin window
- Secure Skins and fast install: skins that clip on securely and cannot be removed by hand. Fixing them is easy and fast – you simply click them onto the grid. No screws are needed. Special notches on the skins allow quick and easy removal with a screwdriver.
- Long lasting and robust: Designed extra tough with an IK08 Impact rating (standard sockets only)
- Building Management: Pro Series offers C-Bus compatibility with Series C-Bus Modules
- Suitable for a range of commercial sectors including retail, transportation, offices and public buildings and education establishments

Clever, Strong, Easy



(XW) White Pro Series socket



(BK) Black Pro Series socket



Circuit ID window



Secure clip-on skin



Impact deflection



Seamless design



IK08 impact resistant



Extensive list of functions

PDL Pro Series



P350VH-XW



P381-XW



P382-XW



P383-XW



P384-XW



P381VWP-XW



P381G



P383G



P385G

Description	Ctn Qty	Item / CatNumber
Switches		
Switch Arch 1G Rocker XW	10	P361-XW
Switch Arch 1G Rocker BK	10	P361-BK
Switch Arch 2G Rocker XW	10	P362-XW
Switch Arch 2G Rocker BK	10	P362-BK
Blank Grid Vert/Horiz XW	10	P350VH-XW
Blank Grid Vert/Horiz BK	10	P350VH-BK
Switch Vert 1G 20A/16AX 250V XW	10	P381-XW
Switch Vert 2G 20A/16AX 250V XW	10	P382-XW
Switch Vert 3G 20A/16AX 250V XW	10	P383-XW
Switch Vert 4G 20A/16AX 250V XW	10	P384-XW
Switch Vert IP44 1G 20A/16AX 250V XW	10	P381VWP-XW
Switch Vert IP44 2G 20A/16AX 250V XW	10	P382VWP-XW
Switch Vert IP44 3G 20A/16AX 250V XW	10	P383VWP-XW
Switch Grids		
Grid Switch Vert/Horiz 1G	10	P381G
Grid Switch Vert/Horiz 2G	10	P382G
Grid Switch Vert/Horiz 3G	10	P383G
Grid Switch Vert/Horiz 4G	10	P384G
Grid Switch Vert/Horiz 5G	10	P385G
Grid Switch Vert/Horiz 6G	10	P386G

PDL Pro Series

Description	Ctn Qty	Item / CatNumber
Switch Skins		
Skin Switch V/H 1G rocker XW	10	P381C-XW
Skin Switch V/H 1G rocker BK	10	P381C-BK
Skin Switch V/H 2G rocker XW	10	P382C-XW
Skin Switch V/H 2G rocker BK	10	P382C-BK
Skin Switch V/H 3G rocker XW	10	P383C-XW
Skin Switch V/H 3G rocker BK	10	P383C-BK
Skin Switch V/H 4G rocker XW	10	P384C-XW
Skin Switch V/H 4G rocker BK	10	P384C-BK
Skin Switch V/H 5G rocker XW	10	P385C-XW
Skin Switch V/H 5G rocker BK	10	P385C-BK
Skin Switch V/H 6G rocker XW	10	P386C-XW
Skin Switch V/H 6G rocker BK	10	P386C-BK
Grid and Skins no Dolly		
Sw Grid and Skins no Dolly V/H 1G XW	10	P331GC-XW
Sw Grid and Skins no Dolly V/H 2G XW	10	P332GC-XW
Sw Grid and Skins no Dolly V/H 3G XW	10	P333GC-XW
Sw Grid and Skins no Dolly V/H 4G XW	10	P334GC-XW
Sw Grid and Skins no Dolly V/H 5G XW	10	P335GC-XW
Sw Grid and Skins no Dolly V/H 6G XW	10	P336GC-XW
Horizontal Sockets		
Socket Sw Horiz Single 10A 250V XW	10	P394-XW
Socket Sw Horiz Sgle 1Ex20A 10A250V XW	10	P394X-XW
SocketSwHorizTwin10A250VXW	10	P395-XW
Socket Sw Horiz Twin 1Ex20A 10A250V XW	10	P395X-XW
Socket Sw Horiz Quad 10A 250V XW	10	P395H4-XW
Socket Sw Horiz Single 15A 250V XW	10	P394-15-XW
Socket Sw Horiz Single 20A 250V XW	10	P394-20-XW
Socket Sw Horiz Twin 15A 250V XW	10	P395-15-XW
Socket Sw Hor Twin RoundEarth 10A250V XW	10	P395R-XW
Socket Sw Hor Twin PwrInd 10A250V XW	10	P395PI-XW
Socket Sw Hor Twin RCDProtect 10A250V XW	10	P395PRCD-XW
Socket Sw Horiz Quad 2ExBlank 10A250V XW	10	P395H4XXUA-XW
Socket Sw Hor Twin2ExUSBCHRG 10A 250V XW	10	P395USB2-XW
Socket Sw Horiz Twin 30mA RCD 10A250V XW	10	P395RCD30-XW
Socket Sw Horiz Twin 10mA RCD 10A250V XW	10	P395RCD10-XW



P383C-XW



P384C-BK



P385C-XW



P386C-BK



P394X-XW



P395X-XW



P395H4-XW



P394-15-XW



P395R-XW



P395USB2-XW



P395H4XXUA-XW



P395RCD30-XW

PDL Pro Series



P394G



P395XG



P395G



P395RG



P395H4XXUAG



P394C-XW



P394XC-BK



P395XC-BK



P394XC-XW



P395RC-XW

Description	Ctn Qty	Item / CatNumber
Horizontal Socket Grids		
Grid Socket Sw Horiz Single 10A 250V	10	P394G
Grid Socket Sw Horiz Single 15A 250V	10	P394-15G
Grid Socket Sw HorizSgl 1Ex20A 10A250V	10	P394XG
Grid Socket SwHorizTwin 1Ex20A 10A250V	10	P395XG
Grid Socket Sw Horiz Twin 10A 250V	10	P395G
Grid Socket Sw Horiz Twin 15A 250V	10	P395-15G
Grid Sock Sw Hor Twin RoundEarth 10A250V	10	P395RG
Grid Socket Sw Horiz Quad 10A 250V	10	P395H4G
Grid Socket SwHorizQuad 2ExBlank 10A250V	10	P395H4XXUAG
Horizontal Socket Skins		
Skin Socket Sw Horiz Single 10A 250V XW	10	P394C-XW
Skin Socket Sw Horiz Single 10A 250V BK	10	P394C-BK
Skin Socket Sw Horiz Single 1ExSw XW	10	P394XC-XW
Skin Socket Sw Horiz Single 1ExSw BK	10	P394XC-BK
Skin Socket Sw Horiz Single 15A 250V XW	10	P394-15C-XW
Skin Socket Sw Horiz Single 15A 250V BK	10	P394-15C-BK
Skin Socket Sw Horiz Twin 10A 250V BK	10	P395C-BK
Skin Socket Sw Horiz Twin 10A 250V XW	10	P395C-XW
Skin Socket Sw Horiz Twin 10A 250V	10	P395C-DB
Skin Socket Sw Horiz Twin 10A 250V RD	10	P395C-RD
Skin Socket SwHorizTwin 1ExSw 10A250V BK	10	P395XC-BK
Skin Socket SwHorizTwin 1ExSw 10A250V XW	10	P395XC-XW
Skin Sock Sw Horiz Twin Round Earth XW	10	P395RC-XW
Skin Sock Sw Horiz Twin Round Earth BK	10	P395RC-BK
Skin Socket Sw Horiz Quad 10A 250V BK	10	P395H4C-BK
Skin Socket Sw Horiz Quad 10A 250V XW	10	P395H4C-XW
Skin Socket Sw Horiz Quad 2ExSw XW	10	P395H4XXUAC-BK
Skin Socket Sw Horiz Quad 2ExSw BK	10	P395H4XXUAC-XW

PDL Pro Series

Description	Ctn Qty	Item / CatNumber
Vertical Sockets		
Socket Sw Vert Twin 10A 250V XW	10	P392-XW
Socket Sw Vert Single 10A 250V XW	10	P391-XW
Socket Sw Vert Twin 1Ex20A 10A 250V XW	10	P392X-XW
Socket Sw Vert Single 15A 250V XW	10	P391-15-XW
Socket Sw Vert Single 30mA RCD 10A250V XW	10	P391RCD30-XW
Socket Sw Vert Twin2ExUSBCHR9 10A250V XW	10	P392USB2-XW
Vertical Socket Grids		
Grid Socket Sw Vert Twin 10A 250V	10	P392G
Grid Socket Sw Vert Single 10A 250V	10	P391G
Grid Socket SwVert Twin 1Ex20A 10A250V	10	P392XG
Grid Socket Sw Vert Single 15A 250V	10	P391-15G
Vertical Socket Skins		
Skin Socket Sw Vert Single 10A 250V XW	10	P391C-XW
Skin Socket Sw Vert Single 10A 250V BK	10	P391C-BK
Skin Socket Sw Vert Single 15A 250V XW	10	P391-15C-XW
Skin Socket Sw Vert Single 15A 250V BK	10	P391-15C-BK
Skin Socket Sw Vert Twin 10A 250V BK	10	P392C-BK
Skin Socket Sw Vert Twin 10A 250V RD	10	P392C-RD
Skin Socket Sw Vert Twin 10A 250V	10	P392C-DB
Skin Socket Sw Vert Twin 10A 250V XW	10	P392C-XW
Skin Socket SwVertTwin 1ExSw XW	10	P392XC-XW
Skin Socket SwVertTwin 1ExSw BK	10	P392XC-BK
Skin Socket Sw Horiz Twin 15A 250V XW	10	P395-15C-XW
Skin Socket Sw Horiz Twin 15A 250V BK	10	P395-15C-BK



P392-XW



P391-XW



P391RCD30G



P392USB2-XW



P392G



P391G



P391-15G



P391C-XW



P391-15C-XW



P392C-BK



P395-15C-XW

PDL Pro Series



P380M32HOB-XW



378M10



P387M4R2-XW



P40CSFM-XW



P387M3T-XW



310ML-RD



310ML24-RD



P380ALRSENSOR-XW



P381AR-XW



P381AHEAT-XW



P380AR32-BK



P381ALIGHT-XW



P381ASENSOR-XW



P387M3T-XW

Description	Ctn Qty	Item / CatNumber
300 Series Mechs Dedicated XW Dolly		
Mech Switch 1way 32A HOB 250V XW	10	P380M32HOB-XW
Mech Switch 1way 32A OVEN 250V XW	10	P380M32O-XW
Switch Mech Intermediate	10	378M10
Mech Switch 1way DP 20AX 250V	10	P380M20DP
Mech Sw 4-pos Rot OFF-1-OFF-2 10A 250V	10	P387M4R2-XW
Mech Rotary 4 pos 250 VAC 10A, OFF-1-2-3	10	P387M4R3-XW
Mech Sw 4-pos Rot OFF-1-2-3 75VA 250V	10	P40CSFM-XW
Mech Switch 3POS Moment Blank 10A250V XW	10	P387M3TM-XW
Mech Switch 3-POS Blank 10A 250V XW	10	P387M3T-XW
Mech Switch 1/2way Moment 10A250V XW	10	P381M10PM-XW
LED Indicators		
Mech LED indicators 250V Red	10	310ML-RD
Mech LED indicators 250V Green	10	310ML-GN
Mech LED indicators 24V Green	10	310ML24-GN
Mech LED indicators 24V Red	10	310ML24-RD
Mech LED indicators Pwr available Amber	10	310MLPA-AM
Mech LED indicators 250V Amber	10	310ML-AM
Mech Sw Rocker Latching Sensor XW	10	P380ALRSENSOR-XW
Mech Sw Rocker Latching Blank XW	10	P380ALR-XW
Mech Sw Rocker Latching Fridge XW	10	P380AFRIDGE-XW
Dolly Rockers		
Dolly Rocker BLANK PK5 XW	10	P381AR-XW
Dolly Rocker BLANK PK5 BK	10	P381AR-BK
Dolly Rocker HEAT PK5 XW	10	P381AHEAT-XW
Dolly Rocker BLANK 32A PK5 XW	10	P380AR32-XW
Dolly Rocker BLANK 32A PK5 BK	10	P380AR32-BK
Dolly Rocker 20A DP COOKER PK5 XW	10	P380A20DPCK-XW
Dolly Rocker FAN PK5 XW	10	P381AFAN-XW
Dolly Rocker LIGHT PK5 XW	10	P381ALIGHT-XW
Dolly Rocker FRIDGE PK5 XW	10	P381AFRIDGE-XW
Dolly Rocker SENSOR PK5 XW	10	P381ASENSOR-XW
Dolly 3-POS Blank 10A 250V XW	10	P387M3T-XW
Dolly 3-POS Blank 10A 250V BK	10	P387M3T-BK

PDL Pro Series

Description	Ctn Qty	Item / CatNumber
Push Button Electronic		
Timer, Time Clock and Switch 10AX with BLE & CTL		356PB10MBTW-VW
Electronic SW 350W 2 Wire	6	356PBSM-VW
Secondary Switch for use with Primary CTL mechs	6	356PBSS-VW
Secondary Switch c/w LED Use with Primary CTL mechs		356PBSSL-VW
Sensor		
PIR Motion Sensor Mech	6	352MPIR-TN
USB		
USB charging mechanism 1.5A shallow	6	342USB-VW
USB Dual charging mechanism 3.1 deep	6	342USB2-VW
USB Dual Charging Mechanism A + C		342USB2AC-VW
Data, Phone, RCA ,TV and HDMI Modules – for grid and cover plates		
Data modules		
Connector RJ45 Cat6	10	319MD-TN
Phone modules		
Telephone BT 2 wire Shutter	10	317M2-TN
TV module and plate		
TV PAL - F Type 1G Plate complete	10	328PF-VW
TV modules		
TV PAL - F Type	10	328MF-TN
TV F Type - F Type 3GHz	10	315MF-TN
HDMI and Audio modules		
HDMI Straight	10	315HDMI-TN
Audio Socket RCA RD+BK	10	340MRB-TN
Connector Banana Audio RD+BK	10	315MBBR-TN

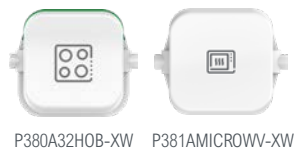

P380A32HOB-XW P381AMICROWW-XW



P381ADISHWSR-XW



P381ALR-BK



P300PBC-XW



P300KBC-BK



P300ALEDB-XW



P300ALEDB-BK



P3TOOL

PDL Pro Series

Description	Ctn Qty	Item / CatNumber
Dolly 3-POS UOD 10A 250V XW	10	P387AUOD-XW
Dolly 3-POS SON 10A 250V XW	10	P387ASON-XW
Dolly 4-pos Rot marked OFF-1-OFF-2 BK	10	P387A4R2-BK
Dolly 4-pos Rot marked OFF-1-2-3 BK	10	P387A4R3-BK
Dolly 3-POS 0/1/2 10A 250V XW	10	P387A012-XW
Dolly 3-POS Auto/OFF/Man 10A 250V XW	10	P387AAOM-XW
Dolly Rocker HOB 32A PK5 XW	10	P380A32HOB-XW
Dolly Rocker HOT WATER PK5 XW	10	P381PHW-XW
Dolly Rocker MICROWAVE PK5 XW	10	P381AMICROWW-XW
Dolly Rocker AUTO/MAN PK5 XW	10	P381PAM-XW
Dolly Rocker ON/OFF PK5 XW	10	P381POF-XW
Dolly Rocker DISHWASHER PK5 XW	10	P381ADISHWSR-XW
Dolly Rocker DRYER PK5 XW	10	P381PDY-XW
Dolly Rocker RANGE 32A PK5 XW	10	P380A32RANGE-XW
Dolly Rocker WASTE PK5 XW	10	P381AWASTE-XW
Dolly Rocker Latching BLANK PK5 XW	10	P381ALR-XW
Dolly Rocker Latching BLANK PK5 BK	10	P381ALR-BK
Accessories		
Push button parts pack white	10	P300PBC-XW
Push button parts pack black	10	P300PBC-BK
Rotary dimmer knob parts pack white	10	P300KBC-XW
Rotary dimmer knob parts pack black	10	P300KBC-BK
3 gang USB A charging station	10	P343H-XW
Protective box IK10 with lockable lid	10	P223H-3A
Module LED 250V Bright White White Dolly	10	P300ALEDB-XW
Module LED 250V Bright White Black Dolly	10	P300ALEDB-BK
Pro Series Skin Tool	10	P3TOOL
Adaptor RJ Systimax AT&T	10	319MAC-TN
Adaptor RJ Tyco Krone Siemon	10	319MKC-TN

Notes



PDL 600 Series Design Excellence



PDL 600 Series

Description	Suits metal plate	Ctn Qty	Item / Cat-Number
600 Series Switches			
Switches, 250V 20A Vertical/Horizontal			
Single module	681M PB/BBZ/SS	10	681
Double module	682M PB/BBZ/SS	10	682
Triple module	683M PB/BBZ/SS	10	683
Grid and Cover Plate Only, Vertical/Horizontal			
OEM blank	686M PB/BBZ/SS	10	650VH
Standard full-face blank	650BM PB/BBZ/SS	10	650BVH
Standard 1 aperture	681M PB/BBZ/SS	10	681VH
Standard 2 aperture	682M PB/BBZ/SS	10	682VH
Standard 3 aperture	683M PB/BBZ/SS	10	683VH
Standard 4 aperture	684M PB/BBZ/SS	10	684VH
Standard 5 aperture	686M PB/BBZ/SS	10	685VH
Standard 6 aperture	686M PB/BBZ/SS	10	686VH
Grid and Cover plates WorkTops and Architrave			
Worktop 1 aperture	688M PB/BBZ/SS	10	688VH
Worktop 2 aperture	689M PB/BBZ/SS	10	689VH
Architrave 1 aperture	661M PB/BBZ/SS	10	661VH
Architrave 2 aperture	662M PB/BBZ/SS	10	662VH
Architrave 3 aperture	Metal plate N/A	10	663VH
Architrave 4 aperture	Metal plate N/A	10	664VH
Grid and Cover Plate with ID Facility			
Standard 1 aperture vertical	Metal plate N/A	10	681VID #
Standard 1 aperture horizontal	Metal plate N/A	10	681HID #
Standard 2 aperture vertical	Metal plate N/A	10	682VID #
Standard 2 aperture horizontal	Metal plate N/A	10	682HID #
Standard 3 aperture horizontal	Metal plate N/A	10	683HID #
Standard 4 aperture vertical	Metal plate N/A	10	684VID #
Standard 4 aperture horizontal	Metal plate N/A	10	684HID #



Available in White only.

PDL 600 Series



626N



526KC



626VC2

Description	Suits metal plate	Ctn Qty	Item / Cat-Number
Range Switch			
Vert/Horiz S.P. 2 loops 250V 32A	680M PB/BBZ/SS	10	680
Vert D.P. 415V 45A	647M BBZ/SS	10	647
Hospitality Card Switches, 250V 16A			
Single vertical key card switch with neon (with card)	626NM PB/BBZ/SS	5	626N #
Card only for above	Metal plate N/A	5	526KC #
Single vertical card operated switch with			
Two circuits (16A each)	626VCM PB/BBZ/SS	5	626VC2 !
Four circuits (12A each)	626VCM PB/BBZ/SS	5	626VC4 !

Available in White only.

! Cards not available from Schneider Electric.

PDL 600 Series

Description	Suits metal plate	Ctn Qty	Item / Cat-Number
Permanent Connection Units, 250V			
Vertical single sw. 20A	682M PB/BBZ/SS	10	651
Vertical single sw. 16A IP56	682M PB/BBZ/SS	1	651VWP
Switches, Waterproof IP56, 250V 16A			
Single vertical	681M PB/BBZ/SS	1	681VWP
Double vertical	682M PB/BBZ/SS	1	682VWP
Double vertical dedicated	682M PB/BBZ/SS	1	682VWPD #
Triple vertical	683WPM PB/BBZ/SS	1	683VWP *
Triple vertical dedicated	683WPM PB/BBZ/SS	1	683VWPD #
4 gang vertical	684M PB/BBZ/SS	1	684VWP *
4 gang vertical dedicated	684M PB/BBZ/SS	1	684VWPD #
Single horizontal	681M PB/BBZ/SS	1	681HWP
Double horizontal	682M PB/BBZ/SS	1	682HWP
Triple horizontal	683WPM PB/BBZ/SS	1	683HWP *
Triple horizontal dedicated	683WPM PB/BBZ/SS	1	683HWPD #
4 gang horizontal	684M PB/BBZ/SS	1	684HWP *
4 gang horizontal dedicated	684M PB/BBZ/SS	1	684HWPD #
Permanent connection unit	682M PB/BBZ/SS	1	651VWP



- # Marked light, fan. Available in White only.
 > Marked light, fan, heat. Available in White only.
 ^ Marked light, fan, heat, heat. Available in White only.
 * Available in White only.

PDL 600 Series

Description	Suits metal plate	Ctn Qty	Item / Cat-Number
Time Switches			
Electronic timer 7 day/24 hour, 15A resistive, 1000W tungsten halogen	646E7M PB/BBZ/SS	1	646E7 [#]
Rotary timer with shield, 16A resistive, 8A inductive, 1350W incandescent, 100mA minimum switching current			
– 7 day, 2hr & 20min intervals	646R24M PB/BBZ/SS	1	646R7 [#]
– 24hr, 20min intervals	646R24M PB/BBZ/SS	1	646R24
Time delay switch, 8.5 min pre-set, 100VA inductive fan load	682M PB/BBZ/SS	1	632 [#]
Light Dimmers			
Transformers – Leading edge suits w/wound, trailing edge suits electronic			
450W Universal (20W minimum)	682M PB/BBZ/SS	1	654
450W Leading edge (20W minimum)	682M PB/BBZ/SS	1	634L
450W Trailing edge (20W minimum)	682M PB/BBZ/SS	1	624T [^]
350W WH Push Button Universal Dimmer	681M PB/BBZ/SS	1	654PB

Available in White only.

^ Do not use with wire wound transformers.

PDL 600 Series

Switch Cover Plates – Metal Finish and Plastic

Polished Brass Cat No.	Brushed Bronze Cat No.	Stainless Steel Cat No.	White Plastic Cat No.
612MPB	612MBBZ	612MSS	612C
646E7MPB	646E7MBBZ	646E7MSS	646E7C
646R24MPB	646R24MBBZ	646R24MSS	N/A
N/A	647MBBZ	647MSS	N/A
650BMPB	650BMBBZ	650BMSS	650CP
661MPB	661MBBZ	661MSS	661C
662MPB	662MBBZ	662MSS	662C
679MPB	679MBBZ	679MSS	679C
680MPB	680MBBZ	680MSS	680C
681MPB	681MBBZ	681MSS	681C
682MPB	682MBBZ	682MSS	682C
683MPB	683MBBZ	683MSS	683C
683WPMPB	683WPMBBZ	683WPMS	N/A
684MPB	684MBBZ	684MSS	684C
686MPB	686MBBZ	686MSS	686C
688MPB	688MBBZ	688MSS	N/A
689MPB	689MBBZ	689MSS	N/A
Listed switch cover plates		10 (Ctn Qty)	



646R24MPB
646R24MBBZ
646R24MSS



650BMPB
650BMBBZ
650BMSS
650CP

Switch cover plates can be used vertically or horizontally.
Security screwed metal switch cover plates are available on request – an extra charge may apply.

PDL 600 Series

Switch Cover Plates – Metal Finish and Plastic

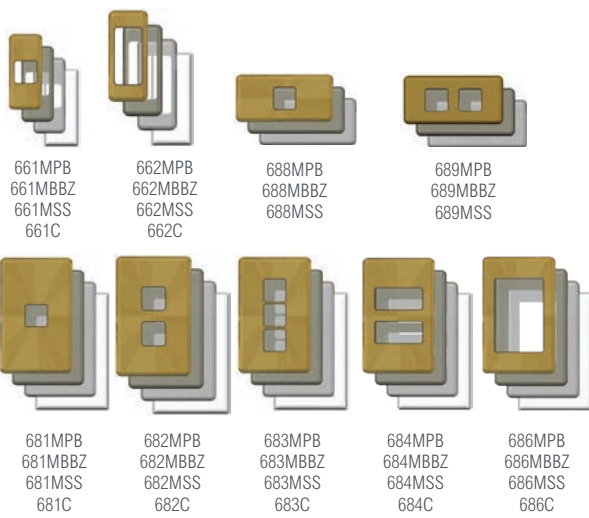

600DCPKD

Description	Ctn Qty	Item / Cat-Number
Decorator Cap		
Decorator Cap	50	600DCPKD

PDL 600 Series

Socket Cover Plates – Metal Finish and Plastic

Polished BrassCat No.	Brushed Bronze Cat No.	Stainless Steel Cat No.	White Plastic Cat No.
691MPB	691MBBZ	691MSS	691C
691XMPB	691XMBBZ	691XMSS	691XC
N/A	N/A	N/A	691RCDC
692MPB	692MBBZ	692MSS	692C
692XMPB	692XMBBZ	692XMSS	692XC
694MPB	694MBBZ	694MSS	694C
694XMPB	694XMBBZ	694XMSS	694XC
694XXMPB	694XXMBBZ	694XXMSS	694XXC
695MPB	695MBBZ	695MSS	695C
695XMPB	695XMBBZ	695XMSS	695XC
698MPB	698MBBZ	698MSS	N/A
699TBMPB	699TMBBZ	699TBMSS	699TBC

Listed socket cover plates

10 (Ctn Qty)



691MPB
691MBBZ
691MSS
691C



691XMPB
691XMBBZ
691XMSS
691XC



692MPB
692MBBZ
692MSS
692C



692XMPB
692XMBBZ
692XMSS
692XC



694MPB
694MBBZ
694MSS
694C



694XMPB
694XMBBZ
694XMSS
694XC



694XXMPB
694XXMBBZ
694XXMSS
694XXC



695MPB
695MBBZ
695MSS
695C

Switch cover plates can be used vertically or horizontally.
Security screwed metal switch cover plates are available on request – an extra charge may apply.

PDL 600 Series

Socket Cover Plates – Metal Finish and Plastic



641C



644C



- 695XMPB
- 695XMBBZ
- 695XMSS
- 695XC



- 699TBMPB
- 699TMBBZ
- 699TBMSS
- 699TBC

Description	Suits metal plate	Ctn Qty	Item / Cat-Number
4 Way Socket Cover Plates			
4 way socket cover plate	Metal plates N/A	5	641C #
4 way socket cover plate	Metal plates N/A	5	644C #

Available in White only.

PDL 600 Series

Description	Suits metal plate	Ctn Qty	Item / Cat-Number
Sockets			
Standard Socket Outlets, Single Vertical, 250V 10A			
Vertical single, switched	691M PB/BBZ/SS	10	691
691 with extra switch	691XM PB/BBZ/SS	5	691X
Standard Socket Outlets, Double Vertical, 250V 10A			
Vertical double, switched	692M PB/BBZ/SS	10	692
692 with neon 'ON' indicators	692M PB/BBZ/SS	5	692N #
692 with extra switch	692XM PB/BBZ/SS	5	692X
Standard Socket Outlets, Quad Vertical, 250V 10A			
Vertical 4 outlet, switched	Metal plate N/A	5	641
641 with 1 x 15A outlet	Metal plate N/A	5	641/15
Standard Socket Outlets, Single Horizontal, 250V 10A			
Horizontal single, switched	694M PB/BBZ/SS	10	694
694 with extra switch	694XM PB/BBZ/SS	5	694X #
694 with two extra switches	694XXM PB/BBZ/SS	5	694XX #
Standard Socket Outlets, Double Horizontal, 250V 10A			
Horizontal double, switched	695M PB/BBZ/SS	10	695
695 with neon 'ON' indicators	695M PB/BBZ/SS	5	695N
695 with extra switch	695XM PB/BBZ/SS	5	695X
Horizontal double, unswitched with separate bases	Metal plate N/A	10	693/2 #
Standard Socket Outlets, Quad Horizontal, 250V 10A			
Horizontal 4 outlet, switched	Metal plate N/A	5	644
644 with 1 x 15A outlet	Metal plate N/A	5	644/15
USB Socket Outlets, 230-240V AC			
Double horizontal with USB	695XM PB/BBZ/SS	10	695USB #
Double vertical with USB	692XM PB/BBZ/SS	10	692USB #

Available in White only.



691



691X



692



692X



641



694



694X



694XX



693/2



695



695X



644



695USB



692USB

PDL 600 Series



Description	Suits metal plate	Ctn Qty	Item / CatNumber
Standard Socket Outlets, 250V 15A			
Vertical single, switched	691M PB/BBZ/SS	5	691/15 #
Vertical double, switched	692M PB/BBZ/SS	5	692/15 #
Horizontal single, switched	694M PB/BBZ/SS	5	694/15 #
Horizontal double, switched	695M PB/BBZ/SS	5	695/15
Standard Sockets, 250V 10A Round Earth Pin			
Vertical single, switched	691M PB/BBZ/SS	5	691R #
Vertical double, switched	692M PB/BBZ/SS	5	692R #
Horizontal double, switched	695M PB/BBZ/SS	5	695R #
TV and Telecom Telephone Outlets			
Television socket outlet– F connect rear	681M PB/BBZ/SS	10	628F
Television socket outlet	681M PB/BBZ/SS	10	628
2 wire telephone jack – 1 outlet	612M PB/BBZ/SS	10	617BT2 #
Worktop Socket Outlets, 250V 10A			
Single, switched	698M PB/BBZ/SS	10	698
Double, switched	Metal plate N/A	10	699
Double, switched (twin base)	699TBM PB/BBZ/SS	10	699TB
Worktop Socket Outlets, 250V 15A			
Single, switched	698M PB/BBZ/SS	5	698/15
Double, switched (twin base)	699TBM PB/BBZ/SS	5	699TB/15 #

Available in White only.

PDL 600 Series

Description	Suits metal plate	Ctn Qty	Item / CatNumber
Worktop Sockets, 250V 10A Round Earth Pin			
Single, switched	698M PB/BBZ/SS	5	698R #
Double, switched (twin base)	699TBM PB/BBZ/SS	5	699TBR #
Socket Outlets with RCD ON Indicator			
Vertical double switched	692XM PB/BBZ/SS	5	692P #
Horizontal double switched	695XM PB/BBZ/SS	5	695P #
Vertical 4 way switched	Metal plate N/A	5	641P #
Horizontal 4 way switched	Metal plate N/A	5	644P #
Sockets with Circuit Identification			
For circuit identification, an opaque cap (supplied) can be engraved before clipping onto the sub plate. Alternatively, a die-cut blank label (also supplied) can be printed and covered with a transparent cap.			
Double vertical socket	692XM PB/BBZ/SS	10	692ID #
Double horizontal socket	695XM PB/BBZ/SS	10	695ID #



692P

695P



641P



692ID

695ID

Available in White only.

PDL 600 Series



Description	Suits metal plate	Ctn Qty	Item / Cat-Number
Shaver Sockets and RCD			
RCD vertical switched socket 10A 30mA		1	691RCD-30 *
RCD vertical switched socket 10A 10mA	691RCDM PB/BBZ/SS	1	691RCD-10 #
RCD horizontal double, switched socket 10A 30mA		1	695RCD-30 #
RCD horizontal double, switched socket 10A 10mA		1	695RCD-10 ^
Plate mount 20A RCD 30mA	686M PB/BBZ/SS	1	696RCD-30 #
Plate mount 20A RCD 10mA	686M PB/BBZ/SS	1	696RCD-10 ^
Universal 110V and 240V shaver socket vertical/horizontal	686M PB/BBZ/SS	1	675 *

Available in white only.

* Available in white and black only.

^ Medical industry product in White, Red and Blue only (lead times may apply).

Notes



PDL Modules for 600 Series



Modules for 600 Series

Description	Ctn Qty	Item / Cat-Number
Switch Modules, 250V*, Rocker		
Ratings: 20A, 16AX fluorescent, M60 to AS/NZS 3133:2003		
2 way, 4 terminal unprinted, 16AX	20	681M20
Press blank, n/o, spring return, 2 way, 4 terminal	20	681M20PB #
Press, n/o, spring return, 2 way, 4 terminal	20	681M20P
Reset, n/o, spring return, 2 way, 4 terminal	20	681M20R #
Bell press, n/o, spring return, 2 way, 4 terminal	20	681M20B
Neon switch (ON or Perm ON) 1 way	20	680M20N
Intermediate, 4 terminal, 16A, 8AX fluorescent	20	678M16
Double pole, 4 terminal, 10A resistive	20	687M10



681M20



678M16



681M20P



681M20B



680M20N



687M10

32 Amp 1 Way Switches

32A 20AX fluorescent, 1 way, 2 terminal, unprinted	20	680M32
--	----	--------

Printed 32A switches

printed 'AIR CON'	20	680M32AC
-------------------	----	----------

printed 'HOB'	20	680M32H
---------------	----	---------

printed 'ON/OFF'	20	680M32IO #
------------------	----	------------

printed 'OVEN'	20	680M32O
----------------	----	---------

printed 'RANGE'	20	680M32R
-----------------	----	---------



680M32



680M32H



680M32O

Switch Modules – Push Button

Latching action, 250V a.c. 16A	10	681MT16
--------------------------------	----	---------

Momentary action, 250V a.c. 10A, 24V d.c. 10A	10	681MT10PB
---	----	-----------



681MT10PBWH

* Special pricing applies for switch engraving other than those listed.
Available in White only.

Modules for 600 Series

Description	Ctn Qty	Item / Cat-Number
Protected Switch Modules, 250V, 16A		
1 way/2 way, 4 terminal with protective lid	20	681M16HF
1 way/2 way, 4 terminal with protective lid		
printed 'ALARM'	20	681M16HFAL #
printed 'FRIDGE'	20	681M16HFF #
printed 'MICROWAVE'	20	681M16HFMW #
printed 'SENSOR'	20	681M16HFS
1 way/2 way, 4 terminal with clear protective lid and labelling card	20	681M16HFCL #
Press, n/o, spring return, 2 way, 4 terminal with protective lid	20	681M16HFP #



681M16HFF



681M16HF



681M20F



681M20L



681M20MW



681M20SE



681M20TV



681M20WT

Dedicated Switch Modules, 250V, 20A

681M20 printed toggle:	All models:	20 (Ctn Qty)	
'AIRCON'	681M20AC	'LIGHT'	681M20L
'APPLIANCE'	681M20AP	'KITCHEN'	681M20KT #
'AUTO/MANUAL'	681M20AM	'LOUNGE'	681M20LO
'DINING'	681M20D	'MICROWAVE'	681M20MW
'D/WASH'	681M20DW	'MIRROR'	681M20MR
'DOOR'	681M20DR	'ON/OFF'	681M20/O
'DRYER'	681M20DY	'OUTSIDE'	681M20O
'FAN'	681M20F	'POOL'	681M20PL #
'FORWARD/REVERSE'	681M20FR	'PUMP'	681M20PU
'FRIDGE'	681M20FG	'SENSOR'	681M20SE
'GAS'	681M20G	'SPA'	681M20S
'GARDEN'	681M20GN	'STAIRS'	681M20ST
'HALL'	681M20HA	'WASH'	681M20WH
'HEAT'	681M20H	'TOWEL'	681M20TL #
'HIGH/FAN/LOW'	681M20HLF	'TV'	681M20TV
'HOOD'	681M20HD	'WASTE'	681M20WT
'HWS'	681M20HWS #		

Available in White only.

681M20 can be printed with Vanity / Up Down / Open Closed / Blinds as a special. A surcharge will apply.

Modules for 600 Series

Description	Ctn Qty	Item / Cat-Number
Rotary Switch Modules, 230V-240V, 16A		
3 position rotary switch, printed 'AUTO/O/MAN'	10	687M3A/M
3 position rotary switch, printed 'I/O/II'	10	687M3I/II #
3 position rotary switch, printed '0,1,2'	10	687M3
4 position rotary switch, printed '0,1,2,3'	10	687M4
4 position rotary switch, printed 'FAN'	10	687M4F #



687M4



687M4F

Switch Module, 250V, 20A

2 way printed toggle marked 'HWS'	20	681M20HWS #
-----------------------------------	----	-------------



681M20HWS

Pull Cord Switch Modules

2 way, 4 terminal, 250V 16A	10	681M16PS #
Momentary contact, 12V DC , 12A, 2 way	10	673MM #



681M16PS

Relay Module

Single pole relay module, 240V AC coil, 16A, 6AX	10	600RM
--	----	-------

Timer Modules

Preset timer module – Settable 15sec-120min delay, 3A resistive	10	648TM
---	----	-------



648TM

PIR Sensor Module

230-250V AC 3A resistive rating. Adjustable lux and time settings	10	100MPIR
---	----	---------



100MPIR

Available in White only.

Modules for 600 Series



654PBM



624TM



652FM



625C3M



1588M



666TMB24



600SM



642MUSB

Description	Ctn Qty	Item / Cat-Number
Light Dimmers, 230V-240V		
450W universal leading/trailing edge	10	654M
450W leading edge (suits w/wound transformers)	10	634LM
450W trailing edge (suits electronic transformers)	10	624TM *
Push Button Universal Dimmer Mod 350W	10	654PBM
Fan Speed Control Modules		
Fan speed controller, 500VA, continuous adjustment	10	625FM
Permanent Connection Module, 250V 16A		
2 way term block with bell mouth	20	651M2
Buzzer Modules		
Piezo buzzer 24V DC, 30mA	20	666TMB24 #
Buzzer module 230-240V AC	20	1588M #
Surge Protection Modules		
Surge protection module with status indicator	10	600SM
USB Charging Modules		
USB Charger Module	1	642MUSB

Available in White only.

* Do not use with wire wound transformers.

Modules for 600 Series

Description	Ctn Qty	Item / Cat-Number
Illuminated Modules, 250V, 12V and 24V		
Red, green, amber (#), clear (#) or blue (#) neon		
250V AC	20	610MN
12V AC/DC LED	20	610ML12 #
24V AC/DC LED	20	610ML24 #
24V DC module with small red LED	20	610TML24 #
24V DC module with large red or green LED	20	666TML24 #
ELV Modules, 12V-24V DC		
Momentary contact Actuator, 2 terminal 24V	20	680TMPB
680TMPB with LED indicator, Green or Red, 4 terminal 24V	20	680TMNPB #
Momentary contact pull cord switch 12V, 12A, 2 way	10	673MM #
Piezo buzzer 24V, 30mA	20	666TMB24 #
Plain and Printed Blank Modules		
Blank module	20	600B
ID module	20	600BID #
Mechanism Shroud		
Mechanism Shroud	40	680S



Available in White only.

Modules for 600 Series



619MD



615MKCWH

Description	Ctn Qty	Item / Cat-Number
Telephone and Data Modules		
BT 2 wire telephone module	10	617M2
Dataplus jack module, category 6, 'PowerSum' rated	10	619MD
Dataplus jack module with hinged lid	10	619MDL
Keystone clip module	10	619MKC
Keystone clip module with hinged lid	10	619MKLC
AT&T/Suttle clip module	10	619MAC
AT&T/Suttle clip module with hinged lid	10	619MALC
Modtap clip module	10	619MM
Keystone Clip	10	615MKC *

* Available in White and Black only.

Modules for 600 Series

Description	Ctn Qty	Item / Cat-Number
TV, Audio and Communications Modules		
TV/FM splitter	10	609M #
BNC outlet	20	616M #
Coaxial connector front/F connector rear		
printed 'TV'	20	628MF
printed 'VIDEO'	20	628MFV #
printed 'SKY'	20	628MFS #
printed 'IN'	20	628MFI #
printed 'OUT'	20	628MFO #
75 Ohm coaxial 'TV'	20	628M
75 Ohm coaxial 'FM'	20	629M #
Through connect module (F connect)		
printed 'TV'	20	615MFTV *
printed 'SKY'	20	615MFSKY *
Banana connector red – audio	20	615MRB
Banana connector black – audio	20	615MBB
TV, Audio and Communication F Type Connections Modules		
White RCA Socket with F-type connector	10	640MFWH #
Yellow RCA Socket with F-type connector	10	640MFYL *
Single HDMI Socket	10	615HDMI #
Switch Modules		
Module ejector tool for removing modules	100	600ME



609M



616M

628M



615HDMIWH



640MFWH



600ME

Available in White only.

* Available in White and Black only.



Saturn Zen – The beauty of simplicity



Saturn Zen

Description	Ctn Qty	Item / CatNumber
Switch with switch and LED fitted		
1 gang Push-Button switch with LED, 20A/16X, 250V	10	Z4061PBL *
2 gang Push-Button switch with LED, 20A/16X, 250V	10	Z4062PBL *
3 gang Push-Button switch with LED, 20A/16X, 250V	10	Z4063PBL *
Switch Grid plates and cover (less switch mech)		
Blank grid plate and assembly	10	Z4060VX *
1 gang grid and plate assembly to suit 60PB	10	Z4061VH *
2 gang grid and plate assembly to suit 60PB	10	Z4062VH *
3 gang grid and plate assembly to suit 60PB	10	Z4063VH *
4 gang grid and plate assembly to suit 60PB	10	Z4064VH *
5 gang grid and plate assembly to suit 60PB Series	10	Z4065VH *
6 gang grid and plate assembly to suit 60PB	10	Z4066VH *
Architrave with Switches and LED fitted		
1 gang Push-Button switch with LED, 20A/16X, 250V	10	Z4061AL *
2 gang Push-Button switch with LED, 20A/16X, 250V	10	Z4062AL *
Architrave Switch grid plates & Cover (less mech)		
1 gang architrave grid and plate assembly to suit 60PB Series	10	Z4061 *
2 gang architrave grid and plate assembly to suit 60PB Series	10	Z4062 *
Switch Mechanisms *Suits Z4060 & 4060 Series Plate ranges		
Saturn Push-Button Switch to suit 4060 Series 20A/16AX, 250V	10	60PB
Saturn Push-Button with LED to suit 4060 Series 20A/16AX, 250V	10	60PBL
Saturn Push-Button press/momentary mech with LED to suit 4060 Series 16A, 250V	5	60PBBPL
Saturn Intermediate Push-Button no LED to suit 4060 Series 20A/16AX, 250V	5	60PBI
4 position switch rotary mechanism	5	60RSM3 *



Z4061PBL-ZW

Z4062PBL-ZW



Z4066VH-ZB

Z4066VH-ZW



Z4062AL-ZW



60PB

60PBL

60PBI

60RSM3

Saturn Zen

Description	Ctn Qty	Item / CatNumber
Lights Dimmers/Fan Speed Controllers		
Fan Controller 3 Speed Fan 250V 75VA	5	Z4060CSFM
Universal Dimmer Mechanism only, 450W 250V	5	4062E450UDM-TR
Knob dimmer / Fan control	5	Z4062EDIM-KB
Universal Push-Button Dimmer (ISPB) integrally switched push button (no switch required) fits standard 4061VH plates	5	4061E2PUDM-TR
Load correction device for LED & CFL loads	5	S31LCDA
Pictograms		
Pack of 60 pictograms button caps	1	60ZPBC *
Range Switches		
Double pole range switch 32A 250V	5	Z4061D32 *
Single pole range switch 45A 415V	5	Z4061/45 *



4060CSFM



4062E450UDM-TR



Z4062EDIM-KB



S31LCDA



Z4062E450UDN



Z4061D32



60ZPBC

* Suits Z4060 Plate range
This range is available in Zen White (-ZW), Zen Black (-ZB)

Saturn Zen

Description	Ctn Qty	Item / CatNumber
Sockets single		
Power outlet single 250V 10A	10	Z4015
Power outlet single with round earth 10A	10	Z4015L
Socket double and quad		
Power outlet double 250V 10A	5	Z4025
Power outlet quad 250V 10A	20	Z4025H2
Socket Double with Extra switch and less switch		
Power outlet double 250V 10A with extra removable 16A switch	5	Z4025XA
Power outlet double 250V 10A with extra aperture (less mechanism)	5	Z4025XUA
USB Charging		
Double socket with USB Charger	5	Z4025USBC
Data grid and cover plates *Suits 30 series mechs		
1 gang grid and plate assembly to suit 30 Series	10	Z4031VH-ZW
2 gang grid and plate assembly to suit 30 Series	10	Z4032VH-ZW
3 gang grid and plate assembly to suit 30 Series	10	Z4033VH-ZW
4 gang grid and plate assembly to suit 30 Series	10	Z4034VH-ZW
5 gang grid and plate assembly to suit 30 Series	10	Z4036VH-ZW
Charger shelf		
Horizontal charger 2 x 1.2 amp charger with shelf	5	Z4032HSUSBC-ZW
Horizontal Shelf cover plate only suits Z4032VH or Z4032HSUSBC	5	Z4032HS-ZW
Parts included in the complete USB charger with shelf: Z4032VH + Z4032HS + 2 x 30USBCM		



Z4015-ZW



Z4015L-ZW



Z4025-ZW



Z4025H2-ZW



Z4025XA-ZW



Z4025USBC



Z4032VH-ZW



Z4033VH-ZB



Z4032HSUSBC-ZW

* 30 Series mechs are found on page A78 - 83
This range is available in Zen White (-ZW), Zen Black (-ZB)



Saturn 250V



Saturn 250V

Description	Ctn Qty	Item / Cat-Number
Switches LED Vertical Mount		
1 gang Push-Button switch with led, 20A/16X, 250V	10	4061PBL
2 gang Push-Button switch with led, horizontal aperture, 20A/16AX, 250V	10	4062PBHL
2 gang Push-Button switch with led, 20A/16AX, 250v	10	4062PBL
3 gang Push-Button switch with led, 20A/16AX, 250V	10	4063PBL
Switch Grid Plate and Covers		
Blank grid and plate assembly	10	4060VX
1 gang grid and plate assembly to suit 60PB Series	10	4061VH
2 gang grid and plate assembly to suit 60PB Series	10	4062VH
3 gang grid and plate assembly to suit 60PB Series	10	4063VH
4 gang grid and plate assembly to suit 60PB Series	5	4064VH
5 gang grid and plate assembly to suit 60PB Series	5	4065VH
6 gang grid and plate assembly to suit 60PB Series	5	4066VH
Switch Mechanisms		
Saturn Push-Button Switch to suit 4060 Series 20A/16AX, 250V	10	60PB
Saturn Push-Button with LED to suit 4060 Series 20A/16AX, 250V	10	60PBL
Saturn Push-Button press/momentary mech with LED to suit 4060 Series 16A, 250V	5	60PBBPL
Saturn Intermediate Push-Button no LED to suit 4060 Series 20A/16AX, 250V	5	60PBI
Rotary Switch - 4 position 10A	5	60RSM3
Saturn Glass printed label cap set	1	60PBC-3A



4061PBL-OM



4062PBHL-PW



4062PBL-PW



4063PBL-OM



4061VH



4062VH



4064VH



4065VH



60PB



60PBL



60PBI



60RSM3



60PBC-3A

This range is available in Pure White (PW), Ocean Mist (OM) and Espresso Black (EB).



4061/45-OM



4062E450UDM-TR



4031VH-PW



4032VH-OM



4032VH-PW

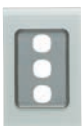

4033VH-OM



4034VH-PW



4061AL-PW



4062AL-OM

Saturn 250V

Description	Ctn Qty	Item / Cat-Number
Electric Range Switches		
Single Pole Range Switch 45A 250V	10	4061/45
Double Pole Range Switch 32A 250V	10	4061D32
Light Dimmers/Fan Speed Controllers		
Universal Dimmer mechanism only, 450W 250V	5	4062E450UDM-TR
Fan Speed Controller 3 speed 250V 75VA	5	4061VF3CSF
Dimmer / Fan control knob (silver)	5	4062EDIM-KB
Grid and Plates to suit 30 Series mechanism		
1 gang grid and plate assembly to suit 30 Series	10	4031VH *
2 gang grid and plate assembly to suit 30 Series	10	4032VH *
3 gang grid and plate assembly to suit 30 Series	10	4033VH *
4 gang grid and plate assembly to suit 30 Series	5	4034VH *
6 gang grid and plate assembly to suit 30 Series	5	4036VH *
<i>Product suits 30 Series Mechs</i>		
Architrave Switch Grid and Plate Covers		
1 gang grid and plate assembly to suit 60PB Series	5	4061
2 gang grid and plate assembly to suit 60PB Series	5	4062
Architrave LED Switches Vertical Mount		
1 gang Push-Button switch with led, 20A/16AX, 250V	5	4061AL
2 gang Push-Button switch with led, 20A/16AX, 250V	5	4062AL

This range is available in Pure White (PW), Ocean Mist (OM).

Saturn 250V

Description	Ctn Qty	Item / Cat-Number
Single Socket – Horizontal Mount		
Single switched socket, 10A, 250V	10	4015
Single switched socket, 10A, 250V – round earth	10	4015L



4015-OM



4015L-PW

Double Socket – Horizontal Mount		
Double switched socket, 10A, 250V	10	4025
Double switched socket, 10A, 250V – extra switch	10	4025X
Double Switch Power outlet with Removable 10A extra switch – extra switches are available in 16A and 32A and printed	10	4025XA



4025-PW



4025X-PW



4025XA-OM

Switches for Extra switch socket		
Switch mechanism assembly 16A, 250V	10	60R16
Switch mechanism assembly 32A, 250V	10	60R32
Switch mechanism assembly 32A, 250V marked COOKER	10	60R32COOK

Specify the colour 3A for Saturn Glass colours ie 60R32-3A

Quad Socket – Horizontal Mount		
Quad switched socket, 10A, 250V	10	4025H2

Specify the colour 3A for Saturn Glass colours ie 60R32-3A



4025H2-PW

USB Charging		
Double socket with USB Charger	1	4025USBC



4025USBC



Saturn Horizon



Saturn Horizon

The Horizon range is available in Horizon Silver (HS) and Horizon Black (HB).

Description	Ctn Qty	Item / Cat-Number
Switches LED Vertical Mount		
1 gang Push-Button switch with led, 20A/16X, 250V	10	4061PBL
2 gang Push-Button switch with led, 20A/16AX, 250V	10	4062PBL
3 gang Push-Button switch with led, 20A/16AX 250V	10	4063PBL
Switch Grid Plate and Covers		
Blank grid and plate assembly	10	4060VX
1 gang grid and plate assembly to suit 60PB Series	10	4061VH
2 gang grid and plate assembly to suit 60PB Series	10	4062VH
3 gang grid and plate assembly to suit 60PB Series	10	4063VH
4 gang grid and plate assembly to suit 60pb Series	5	4064VH
5 gang grid and plate assembly to suit 60pb Series	5	4065VH
6 gang grid and plate assembly to suit 60pb Series	5	4066VH
Architrave LED Switches Vertical Mount		
1 gang Push-Button switch with led, 20A/16AX, 250V	5	4061AL
2 gang Push-Button switch with led, 20A/16AX, 250V	5	4062AL
Architrave Switch Grid and Plate Covers		
1 gang grid and plate assembly to suit 60PB Series	5	4061
2 gang grid and plate assembly to suit 60PB Series	5	4062
Switch Mechanisms		
Saturn Push-Button Switch to suit 4060 Series 20A/16AX, 250V	10	60PB
Saturn Push-Button with LED to suit 4060 Series 20A/16AX, 250V	10	60PBL
Saturn Push-Button press/momentary mech with LED to suit 4060 Series 16A, 250V	5	60PBBPL
Saturn Intermediate Push-Button no LED to suit 4060 Series 20A/16AX, 250V	5	60PBI
Saturn Horizon printed label cap set	1	60PBC-CC



4061PBL



4062PBL



4063PBL



4061VH



4062VH



4064VH



4065VH



4061AL



4062AL



60PB



60PBL



60PBC-CC



60PBI



4061/45



4062E450UDM-TR



4031VH

4032VH



4032VH

4033VH

4034VH

Saturn Horizon

The Horizon range is available in Horizon Silver (HS) and Horizon Black (HB).

Description	Ctn Qty	Item / CatNumber
Electric Range Switches		
Single Pole Range Switch 45A 250V	10	4061/45
Double Pole Range Switch 32A 250V	10	4061D32
Light Dimmers/Fan Speed Controllers Rotary		
Universal Dimmer mech only, 450W 250V	5	4062E450UDM-TR
Fan Speed Controller 3 speed 250V 75VA	5	4061VF3CSF
Dimmer/Fan Control Knob (to match Horizon fascia)	5	4062EDIM-KB-CC
Grid and Plates to suit 30 Series mechanism		
1 gang grid and plate assembly to suit 30 Series	10	4031VH *
2 gang grid and plate assembly to suit 30 Series	10	4032VH *
3 gang grid and plate assembly to suit 30 Series	10	4033VH *
4 gang grid and plate assembly to suit 30 Series	5	4034VH *
6 gang grid and plate assembly to suit 30 Series	5	4036VH *

Suits 30 Series Mechs

Saturn Horizon

The Horizon range is available in Horizon Silver (HS) and Horizon Black (HB).

Description	Ctn Qty	Item / Cat-Number
Socket Outlets Switched Horizontal		
Single switched socket, 10a, 250v	10	4015
Single switched socket, 10a, 250v – round earth	10	4015L
Double switched socket, 10a, 250v	10	4025
Double switched socket, 10a, 250v – extra switch	10	4025X
Double Switch Power outlet with Removable 10A extra switch – extra switches are available in 10A and 32A and printed	10	4025XA
Switches for Extra switch socket		
Switch mechanism assembly 16A, 250V	10	60R16
Switch mechanism assembly 32A, 250V	10	60R32
Switch mechanism assembly 32A, 250V marked COOKER	10	60R32COOK
<i>Specify the colour CC for Saturn Horizon colours ie 60R32-CC</i>		
Quad Socket – Horizontal Mount		
Quad switched socket, 10a, 250v	10	4025H2
USB Charging		
Double socket with USB Charger	1	4025USBC



4015L



4015



4025



4025X



60R32



60R32COOK



4025XA



4025H2



4025USBC



Metal Plate Series Sleek and stylish metal



Metal Plate Series

Description	Ctn Qty	Item / CatNumber
Flush Switches		
<i>This range is available in White Electric (WE), Black (BK).</i>		
“BSL” and “BBSL” Style Flat Plate		
BSL and BBSL plate measurements: 130x85mm, 1.2mm thick, 84mm mounting centres		
Switch 1 gang 250V 10A – stainless steel	5	BSL31VA
Switch 1 gang 250V 10A – brass	5	BBSL31VA
Switch 2 gang 250V 10A – stainless steel	5	BSL32VA
Switch 2 gang 250V 10A – brass	5	BBSL32VA
Switch 3 gang 250V 10A – stainless steel	5	BSL33VA
Switch 3 gang 250V 10A – brass	5	BBSL33VA
Flush Architrave Switches		
<i>This range is available in White Electric (WE), Black (BK).</i>		
Architrave Switch 1 gang 250V 10A – stainless steel	5	B31A
Architrave Switch 1 gang 250V 10A – brass	5	BB31A
Architrave Switch 2 gang 250V 10A – stainless steel	5	B32A
Architrave Switch 2 gang 250V 10A – brass	5	BB32A
Architrave Switch 3 gang 250V 10A - stainless steel	5	B33A
Architrave Switch 3 gang 250V 10A - brass	5	BB33A



BSL31VA



BBSL31VA



BSL32VA



B33A



BB32A



B31A

NB All exposed moulded parts in the metal plate range are made from chemical resistant material. BSL designates Stainless Steel. BBSL designates Brass.

Metal Plate Series



BSL31VH



BSL32VH



BSL34VH

Description	Ctn Qty	Item / CatNumber
Grids with BSL or BBSL Style Plates		
BSL and BBSL plate measurements: 130x85mm, 1.2mm thick, 84mm mounting centres *Suits 30 Series Mechanisms Page 78-83		
BSL stainless steel plate with 1 gang grid	5	BSL31VH
BBSL brass plate with 1 gang grid	5	BBSL31VH
BSL stainless steel plate with 2 gang grid	5	BSL32VH
BBSL brass plate with 2 gang grid	5	BBSL32VH
BSL stainless steel plate with 3 gang grid	5	BSL33VH
BBSL brass plate with 3 gang grid	5	BBSL33VH
BSL stainless steel plate with 4 gang grid	5	BSL34VH
BBSL brass plate with 4 gang grid	5	BBSL34VH
BSL stainless steel plate with 5 gang grid	5	BSL35VH
BBSL brass plate with 5 gang grid	5	BBSL35VH
BSL stainless steel plate with 6 gang grid	5	BSL36VH
BBSL brass plate with 6 gang grid	5	BBSL36VH

NB All exposed moulded parts in the metal plate range are made from chemical resistant material. BSL designates Stainless Steel. BBSL designates Brass.

Metal Plate Series

Description	Ctn Qty	Item / CatNumber
Socket Outlets, Switched Horizontal		
Single Switched Socket		
BSL and BBSL plate measurements: 130x85mm, 1.2mm thick, 84mm mounting centres		
Power outlet single 250V 10A	1	BSL15A
Power outlet single 250V 10A	5	BBSL15A
Power outlet single 250V 10A with non removable extra switch	1	BSL15XA
Power outlet single 250V 10A with non removable extra switch	5	BBSL15XA
Twin Switched Sockets		
BSL and BBSL plate measurements: 130x85mm, 1.2mm thick, 84mm mounting centres		
Power outlet double 250V 10A	5	BSL25A
Power outlet double 250V 10A	5	BBSL25A
Power outlet double 250V 10A with extra removable switch	5	BSL25XA
Power outlet double 250V 10A with extra removable switch	5	BBSL25XA



BSL15A



BSL15XA



BSL25XA



BBSL25A



BSL25A

NB All exposed moulded parts in the metal plate range are made from chemical resistant material. BSL designates Stainless Steel. BBSL designates Brass.

Modules for Saturn Series (60 mech)



Modules for Saturn Series (60 mech)



Modules for Saturn Series (60 mech)

Description	Ctn Qty	Item / CatNumber
Switch Mechanisms		
Saturn Push-Button press/momentary mech with LED to suit 4060 Series 16A, 250V	5	60PBBPL *
Saturn Intermediate Push-Button no LED to suit 4060 Series 20A/16AX, 250V	5	60PBI *
4 position switch rotary mechanism	5	60RSM3 *
Switches for Extra switch socket		
Switch mechanism assembly 16A, 250V	5	60R16
Switch mechanism assembly 32A, 250V	5	60R32
Switch mechanism assembly 32A, 250V marked COOKER	5	60R32COOK
<i>Specify the colour ZB and ZW for Saturn Zen colours ie 60R32-ZW</i>		
Lights Dimmers/Fan Speed Controllers		
3 Speed Fan Controller Mechanism only, 75VA 250V	5	4060CSFM-CC
Universal Dimmer Mechanism only, 450W 250V	5	4062E450UDM-TR
Dimmer/Fan Control Knob (to match horizon fascia)	5	4062EDIM-KB-CC
Universal Push-Button Dimmer (ISPB) integrally switched push button (no switch required) fits standard 4061VH plates	5	4061E2PUDM-TR
S31LCDA Load corrective device for LED and CFL loads	5	S31LCDA



60RSM3



60R16



4061E2PUDM-TR



S31LCDA

* Suits 4060 and Z4060 Plate ranges

Modules for Saturn Series (60 mech)



60PBC-3A



4000VH1-WE

Description	Ctn Qty	Item / Cat-Number
Accessories		
Pack of 60 labelled button caps - suits 4060 series	10	60PBC-3A
Pack of 60 printed and blank labelled button caps suits 4060 series Horizon HB and HS	10	60PBC-CC
Mounting box to suit 4025h2 quad socket	10	2157H2
Mounting bracket to suit 4025h2 quad socket	5	2154H2
Mounting frames suits switches and sockets. Available in White (WE), Soft Grey (SG) Cream (CM)	5	4000VH1
Mounting frames to suit quad horizontal sockets. Available in Black (BK) and White (WE)	5	4000H2



30 Series modules to suit Clipsal Plates





30M



30USM



30MI



30PB



30PBL

30 Series Modules

This range is available in White (WE) and Black (BK).

Description	Ctn Qty	Item / Cat-Number
Switch Mechanisms		
250V 10A 1 way/2 way	10	30M
250V 20A/16AX 1 way/2 way	10	30USM
250V 10A – intermediate	5	30MI
250V 10A press/momentary rocker printed (PRESS)	5	30MBPR
250V 10A double pole – single throw	5	30MD
250V 10A 2 way – double pole – double throw	5	30MD2 *
250V 20A double pole	10	30MD20
250V 35A 1 way/2 way	5	30M35
Toggle key actuated 250V 20A 1 way/2 way	5	30TKM *
250V 10A 2 way rocker with neon indicator	5	30/2NM *

Impress Switch Mechanisms

Push-Button mechanism 20A/16AX	10	30PB
Push-Button mechanism 20A/16AX c/w LED	10	30PBL
Push-Button press/momentary 20A/16AX	10	30PBBP
Push-Button press/momentary 20A/16AX c/w LED	10	30PBBPL *
Push-Button Intermediate 16A/10AX	10	30PBI *

*Available in White (WE) only.

30 Series Modules

Description	Ctn Qty	Item / Cat-Number
Light Dimmer Mechanisms		
Leading edge – suitable for use with incandescent and iron core transformers. Trailing edge – suitable for use with incandescent and electronic transformers. Universal Dimmer suits Leading, Trailing and Fan applications		
Dimmer mechanism, 250V 400W LED	5	32ELEDM



32E450UDM

Fan Speed Controller Mechanisms		
Fan speed controller, 250V 500W, mechanism only	5	32E500FM #



31EPUDM

Illuminated Modules, 250V, 12V and 24V		
Red, Amber or Blue Neon 250V AC	10	30N *
Amber Neon Marked "Power Available" 250V AC	10	30NPA *
Amber or Green Neon 12V AC/DC	10	30N12 *
Amber, Green or Blue Neon 24V AC/DC	10	30N24 *



32E500FM

*Available in White (WE) only.
Available in White/Black only.

30 Series Modules



30USBCM



USBC-CAPS



30BCRM



30FFPFMS



30FAVB



30HDMIA-WE



30HDMIS-WE

Description	Ctn Qty	Item / Cat-Number
-------------	---------	-------------------

USB Charger Mechanisms

USB Charger mechanism with white cap	1	30USBCM
--------------------------------------	---	---------

Coloured caps for USB mechanism pack of 5	10	USBC-CAPS *
---	----	-------------

Available in Arctic Silver (3A), Chrome Shadow (3S), Black (BK), Cream (CM), Dark Blue (DB), Green (GR), Red (RD), and Soft Grey (SG)

Antenna Mechanisms

Connection Sockets and Plugs

TV antenna socket 75 Ohm	20	30TV75M *
--------------------------	----	-----------

"F" type connection 75 Ohm to suit "PAY TV"	20	30PFM *
---	----	---------

Audio connectors RCA (pair)	10	30SPK/2 *
-----------------------------	----	-----------

Banana connector – red	10	30BCRM *
------------------------	----	----------

Banana connector – black	10	30BCBM *
--------------------------	----	----------

Socket F Type – PAL Female Straight	10	30FFPFMS
-------------------------------------	----	----------

Socket F Type Av Composite Rgb	5	30FAVRGB *
--------------------------------	---	------------

Socket F Type Av Composite Rwy	5	30FAVRWY *
--------------------------------	---	------------

Socket F Type Av Digital Audio	5	30FAVRWO *
--------------------------------	---	------------

Socket F Type Composite Video	5	30FAVY *
-------------------------------	---	----------

Socket F Type Av – Sub Woofer	5	30FAVB *
-------------------------------	---	----------

HDMI Adaptors

Straight Rear connection, White	1	30HDMIS-WE *
---------------------------------	---	--------------

Angled Rear connection, White	1	30HDMIA-WE *
-------------------------------	---	--------------

*Available in White (WE) only.

30 Series Modules

Description	Ctn Qty	Item / CatNumber
Sundry Items – Standard Range		
Circuit Identification Products		
Removable plug to suit 30 Series	20	30P *
No 9 screws caps 1 bag of 100 screws caps	100	9 *
Mounting clip moulded surround	20	B30GFZ
Mechanism mounting clip – suit 1mm thick sheet	10	F30Z1 *
Mechanism mounting clip – suit 1.5mm thick sheet	10	F30Z1.5 *
Mechanism mounting clip – suit 2mm thick sheet 22.5mm square hole	10	F30Z2 *
Cable Connection Accessories		
Grommet to suit up to 1.5mm ² ordinary duty flex cord	10	38A *
Grommet to suit up to 2.5mm ² ordinary duty with clamp	10	38HD *
Cord outlet terminal block with grommet to suit 30 series plates	10	38TB
Connector Mechanisms		
Category 6 Connector Mechanisms		
Modular socket, Cat6, 568A, RJ45 with flexible locking tabs	1	30RJ45SMA6C *
Modular socket, Cat6, 568A, RJ45 with flexible locking tabs, shuttered	1	30RJ45SMA6SHC-WE *



9



F30Z1.5



38TB



38HD



30RJ45SMA6C-WE



30RJ45SMA6SHC-WE

*Available in White (WE) only.



PDL Modena 800 Series



PDL Modena 800 Series™

Description	Ctn Qty	Item / Cat-Number
Modena 800 Series™		
Switches, 250V 16AX Fully Assembled		
1 gang large rocker SP 2W	10	881*
2 gang medium rocker SP 2W	10	882*
3 gang standard rocker SP 2W	10	883*
Modena Vertical Switches, 250V 16AX Fully Assembled		
1 gang	10	881V*
2 gang	10	882V*
3 gang	10	883V*
Sockets, 250V 10A Fully Assembled		
Switched single vertical 10A, no indicator included	10	891A*
Switched single horizontal 10A, no indicator included	10	894*
Switched single horizontal 10A, blue LED indicator	1	894BL*
Sockets, 250V 10A Integrally Switched		
Double vertical 10A, amber neon indicators	5	892A*
Double horizontal 10A, amber neon indicators	5	895A*
Double vertical 10A, blue LED indicators	1	892ABL*
Double horizontal 10A, blue LED indicators	1	895ABL*
USB Charger – Fully Assembled		
USB Charger	1	894USB
Light Dimmers – Fully Assembled		
Dimmer – universal leading/trailing edge 450W	1	854*
Dimmer – trailing edge 450W	1	824T*
Dimmer – leading edge 450W	1	834L*
Push button universal dimmer 350W (S2)	5	854PB
Fan Speed Controllers – Fully Assembled		
Fan Speed Controller – 500W	1	825F*
Permanent Connection Unit		
Permanent Connection Unit, 250V 16A	1	851*
Television Outlet		
TV Outlet, PAL with F Rear	1	828F*



881



882



883



881V



882V



883V



891A



894



892A



895A



894USB



851



824T



854PB



825F



828F

* Available in White and Black.

PDL Modena 800 Series™



800GV



800G



800G2H



800G10

Description	Ctn Qty	Item / Cat-Number
Modena Vertical Grid Plates		
Modena Vertical Grid Plate	5	800GV
Modena Vertical Plastic Surrounds		
Vertical white	5	800PSVWH
Vertical black	5	800PSVBK
Vertical blue	5	800PSVBL
Vertical charcoal	5	800PSVCC
Vertical champagne	5	800PSVCH
Vertical chrome	5	800PSVCM
Vertical gunmetal	5	800PSVGM
Vertical platinum	5	800PSVPT
Vertical red	5	800PSVRD
Modena Grid Plates		
Standard grid	5	800G
Double horizontal grid	15	800G2H
Double vertical grid	15	800G2V
Screw caps (bag of 10, required for CM surrounds)	10	800G10

PDL Modena 800 Series™

Description	Ctn Qty	Item / Cat-Number
Modena Standard Plastic Surrounds		
Standard white	5	800PSWH
Standard black	5	800PSBK
Standard blue	5	800PSBL
Standard charcoal	5	800PSCC
Standard champagne	5	800PSCH
Standard chrome	5	800PSCM
Standard gunmetal	5	800PSGM
Standard platinum	5	800PSPT
Standard red	5	800PSRD
Modena Double Vertical Plastic Surrounds		
Double vertical white	20	800PS2VWH
Double vertical black	20	800PS2VBK
Double vertical blue	20	800PS2VBL
Double vertical charcoal	20	800PS2VCC
Double vertical champagne	20	800PS2VCH
Double vertical chrome	20	800PS2VCM
Double vertical gunmetal	20	800PS2VGM
Double vertical platinum	20	800PS2VPT
Double vertical red	20	800PS2VRD



800PS



800PS2V



800PS2H

PDL Modena 800 Series™



800FB2H



800FB2V



800WBC

Description	Ctn Qty	Item / Cat-Number
Modena Double Horizontal Plastic Surrounds		
Double horizontal white	20	800PS2HWH
Double horizontal black	20	800PS2HBK
Double horizontal blue	20	800PS2HBL
Double horizontal charcoal	20	800PS2HCC
Double horizontal champagne	20	800PS2HCH
Double horizontal chrome	20	800PS2HCM
Double horizontal gunmetal	20	800PS2HGM
Double horizontal platinum	20	800PS2HPT
Double horizontal red	20	800PS2HRD
Boxes and Brackets *		
Double vertical flush	5	800FB2V
Double horizontal flush	5	800FB2H
Modena mounting block shallow 16mm	1	449CSD-WE
Modena mounting block standard 34mm	1	449C-WE
Modena backing plate 11mm	1	449BAP-WE

* All mounting boxes and brackets are general accessories.



PDL Modules for Modena 800 Series



PDL Modules for Modena 800 Series



880TPB1



880TPB2



860M16



881M16S



882M10N



881M16L



881M16M



881M16V























Description	Ctn Qty	Item / Cat-Number
Pushbutton Switch Modules 250V		
Latching, Single 16AX SP 2W, standard module	(S2)	5 880TPB1*
Latching, Double 16AX SP 2W, standard module	(S2)	5 880TPB2*
Momentary, Single 10AX SP 2W, standard module	(S2)	5 880MT1SPB*
Momentary, Double 10AX SP 2W, standard module	(S2)	5 880MT2SPB*
Rocker Switch Modules 250V		
Half-standard module 16AX SP 1W	(S1)	20 860M16*
Half-standard module 16AX SP 2W	(S1)	20 861M16**
Standard module 16AX SP 2W	(S2)	10 881M16S*
Double Pole 10A DP 2W (with amber neon)	(S2)	10 882M10N*
Double Pole 10A DP 2W (with blue neon)	(S2)	10 882M10NBL*
Intermediate switch 10AX (with amber neon)	(S2)	10 882M10N^*
Intermediate switch 10AX (with blue neon)	(S2)	10 882M10NBL^*
Standard module 16AX SP 2W (press)	(S2)	10 881M16SP*
Medium module 16AX SP 2W	(S3)	20 881M16M*
Extended module 16AX SP 2W	(S4)	10 881M16V*
Large module 16AX SP 2W	(S6)	10 881M16L*

Switch sizing to Grid plates	Horizontal Grid 800G	Vertical Grid 800V
S1 switch fits		
S2 switch fits		
S3 switch fits		
S4 switch fits		
S6 switch fits		

* Available in White and Black.
No indicator options available.
^ Requires external cable straps.

PDL Modules for Modena 800 Series

Switch Modules 250V – Dedicated Function

FUNCTION		SIZE	CODE	ICON	FUNCTION	SIZE	CODE	ICON
Half-Standard Module Sizes, 1W, 16A			(S1)	Part Numbers as Below		16.30		
Standard Module Sizes, 16A			(S2)	Part Numbers as Below		17.80		
Standard Module Sizes, 32A			(S2)	Part Numbers as Below		34.20		
AIRCON	Standard	881M16SAC		MIRROR	Standard	881M16SMR		
	Half Standard	860M16AC			Half Standard	860M16MR		
BELL(Momentary)	Standard	881M16SB		ON / OFF	Standard	881M16SIO		
	Half Standard	860M16B			Half Standard	860M16IO		
DISHWASHER	Standard	881M16SDW		OUTSIDE	Standard	881M16SO		
	Half Standard	860M16DW			Half Standard	860M16O*		
FAN	Standard	881M16SF		PRESS(Momentary)	Standard	881M16SP		
	Half Standard	860M16F*			Half Standard	860M16P		
FRIDGE	Standard	881M16SFG		PRESS(Momentary, Unprinted)	Standard	881M16SPB		
	Half Standard	860M16FG			Half Standard	860M16PB		
HEAT	Standard	881M16SH		PUMP	Standard	881M16SPU		
	Half Standard	860M16H*			Half Standard	860M16PU		
HOB	Standard	881M32SNH		RANGE /OVEN	Standard	881M32SNR		
	Half Standard	-			Half Standard	-		
HOOD	Standard	881M16SHD		SENSOR	Standard	881M16SSE		
	Half Standard	860M16HD			Half Standard	860M16SE		
HWS	Standard	881M16SHWS		SPA	Standard	881M16SS		
	Half Standard	860M16HWS			Half Standard	860M16S		
LIGHT	Standard	881M16SL		WASH	Standard	881M16SWH		
	Half Standard	860M16L*			Half Standard	860M16WH		
MICRO-WAVE	Standard	881M16SMW		WASTE	Standard	881M16SWT		
	Half Standard	860M16MW			Half Standard	860M16WT		

* Note: The Half Standard Module 2 way switches (861M16) are also available as printed versions @ \$15.60.
Replace '860M16' in the part number shown above with '861M16'.

PDL Modules for Modena 800 Series



881M32SNRBLWH



881M32SNHBLWH



894M



894MA



895MA

Description	Ctn Qty	Item / Cat-Number
32A Rocker Switch Modules – pre-fitted amber neon		
Standard module size, 32A, SP, 2W		
Unprinted, amber neon pre-fitted	(S2)	15 881M32SN *
HOB icon, amber neon pre-fitted	(S2)	15 881M32SNH *
RANGE icon, amber neon pre-fitted	(S2)	15 881M32SNR *
32A Rocker Switch Modules – pre-fitted blue LED		
Standard module size, 32A SP 2W		
Unprinted, blue LED pre-fitted	(S2)	15 881M32SNBL *
HOB icon, blue LED pre-fitted	(S2)	15 881M32SNHBL *
RANGE icon, blue LED pre-fitted	(S2)	15 881M32SNRBL *
Switched Socket Outlet Modules 250V 10A		
Single horizontal module 10A – no indicator fitted	(S6)	10 894M *
Single horizontal module 10A – blue LED fitted	(S6)	10 894MBL *
Integrally Switched Socket Outlet Modules 250V 10A		
Single vertical module 10A	(S4)	15 891MA *
Single horizontal module 10A	(S4)	15 894MA *
Double vertical module 10A – amber neons fitted	(S6)	10 892MA *
Double vertical module 10A – blue LEDs fitted	(S6)	10 892MABL *
Double horizontal module 10A – amber neons fitted	(S6)	10 895MA *
Double horizontal module 10A – blue LEDs fitted	(S6)	10 895MABL *
Switched Socket Outlet Modules 250V 15A		
Switched single horizontal module 15A	(S6)	10 894M/15 *

* Available in White and Black.

PDL Modules for Modena 800 Series

Description	Ctn Qty	Item / Cat-Number
Switched Socket Outlet Modules 250V 15A		
Double vertical module 15A – no indicators fitted	(S6) 10	892MA/15 *
Double horizontal module 15A – no indicators fitted	(S6) 10	895MA/15 *
Data Keystone Clips		
Single Keystone Clip	(S2) 10	815MKC1 **
Double Keystone Clip	(S2) 10	815MKC2 **
For use with Actassi and Schneider Electric data jacks		



815MKC1



815MKC2

* Available in White and Black.

See page A51 of 'Modules of 500 and 600 Series' for compatibility.

^ Only available in White

PDL Modules for Modena 800 Series



815MB



815MF2



815MST35



840MFRGB



840MFRWY



815USB2



815HDMI2WH



815USB1



815HDMI1WH



842MUSB

Description	Size	Ctn Qty	Item / Cat-Number
Audio/Video Modules			
Banana connector (red and black) module	(S2)	10	815MB *
Dual F connector module (Sky approved connector)	(S2)	10	815MF2 *
Audio / Video & Data F Type Connections Modules			
RCA Module with F type connector (Red,Green,Blue)	(S2)	10	840MFRGB *
RCA Module with F type connector (Red,White,Yellow)	(S2)	10	840MFRWY *
Single HDMI Socket	(S2)	10	815HDMI1 #
Double HDMI Socket	(S2)	10	815HDMI2 #
Double USB Socket	(S2)	10	815USB2 #
3.5mm Stereo Socket	(S2)	10	815MST35 #
VGA Socket	(S2)	10	815MVGA #
USB Charging Modules			
800 Series USB Charging module	(S2)	1	842MUSB *

Only available in White.

* Available in White and Black.

PDL Modules for Modena 800 Series

Description	Size	Ctn Qty	Item / Cat-Number
Blank Modules			
Blank half module	(S1)	20	860BM *
Blank standard module	(S2)	10	880BM *
Blank full plate	(S6)	5	880BML *
600/500 Series Modular Range Adaptor			
Adaptor to convert 600/500 Series modules	(S2)	10	800MA *
Clipsal 30M Mech Adaptor			
Adaptor to convert Clipsal 30M mechanisms	(S2)	10	800MAC *
Indicator Inserts 240V			
Amber neon lamp insert – suits most modules	–	10	800N240
Blue LED insert – single strand for sockets	–	10	800L240SBL
Blue LED insert – multi strand for switches	–	10	800L240MBL
Module Ejector			
800 Series module ejector	–	10	800ME



* Available in White and Black.



General Wiring Accessories



PDL Mounting Accessories

Description	Ctn Qty	Item / Cat Number
Flush Boxes		
Plastic flush box Plastic threads 45mm deep	100	144P
Plastic flush box Metal Thread 45mm deep	100	144M
Poured concrete installation 1 gang (50mm deep)	20	140C
Concrete block installation 1 gang (92mm deep)	20	141C
2 gang metal flush box – suits dual cover plates (55mm deep)	4	149
Quad Socket Plastic Wall Box, Iconic	20	3157/4PRM
Mounting Brackets		
Plastic mounting bracket	100	145V
Protective shroud to fit standard brackets	25	146S
800 Series double vertical bracket	5	800FB2V
800 Series double horizontal bracket	5	800FB2H



144M



140C

141C



3157/4PRM



145V

PDL Mounting Accessories



137MB-VW



300SMB & 300DMB

Description	Ctn Qty	Item / Cat Number
Mounting Blocks		
Standard Mounting Block, 34mm depth	10	137MB-VW
Iconic Mounting Block, 32mm depth	10	300SMB-VW
Iconic Mounting Block, 40mm depth	5	300DMB-VW
Iconic Mounting Block Quad Socket 38mm	20	395H4MB-VW
Quad socket Iconic Wall Box	10	3157/4PRM
4 gang mounting block, round conduit (fits 641, 644)	5	640RC #
4 gang mounting block, square conduit (fits 641, 644)	5	640SC #

Available in White only.

PDL General Wiring Accessories

Description	Ctn Qty	Item / Cat Number
Junction Boxes, Terminals and Connector Strips		
32A 500V 4 single screw terminal junction box	10	544 #
40A 500V junction box, 3 single and 1 double screw terminals, fully shrouded	10	544J #
Single terminal 40A (bulk 50)	1	501J/50
10 way 32A orange 60° max connector strip	20	151
10 way 32A anti-track 60° max connector strip	20	152

Fixing Screws			
Screws, 600 Series:	16mmx6–32 UNC	100	201
	30mmx6–32 UNC	100	202
	50mmx6–32 UNC	100	204

These products are only sold in packets of 100 screws



Available in White only.

PDL General Wiring Accessories

Description	Ctn Qty	Item / Cat Number
Surface Sockets		
10A surface socket – single	10	51SS



Assorted Switches and Sockets			
Appliance sockets:			
10A screw terminal	1-2mm panel thickness	20	193/1 #
	2-3.5mm panel thickness	20	193/2 #
15A screw terminal	1-2mm panel thickness	20	193/15/1 #
	2-3.5mm panel thickness	20	193/15/2 #
Appliance socket 10A: tab terminal		20	194 *

Range Plugs and Socket			
4 pin 32A socket suitable for 1 and 2ø ranges		10	576 #
4 pin 32A plug with 1.5m flex for 1 and 2ø ranges		1	976 #
4 pin 32A plug suitable for 1 and 2ø ranges		1	976P #



Suspension Sockets			
Switched cord/pendant connector		20	927 #
Switched cord/pendant with plug		20	927P #



Available in White only.
* Available in White and Black only.

PDL General Wiring Accessories

Description	Ctn Qty	Item / Cat Number
900 Series Plugs, Connectors and Flush Socket		
Plug heavy duty 10A, white, black, clear	20	901
Plug heavy duty plug 15A, white, black	20	901/15
Plug heavy duty 10A, white, black, clear	20	905
Plug heavy duty 15A, white, black	20	905/15
Plug heavy duty 10A, round earth	20	905R #
905 with locking ring	20	905LR #
Hookgrip plug 10A	20	903 #
Cord connector heavy duty 10A, white, black, clear	20	925R
Cord connector heavy duty 15A, white, black, clear	20	925R15
Switched cord/pendant connector	20	927 #
Switched cord/pendant with plug	20	927P #
Plug Tapon side entry, white, black, clear	20	940
Flush socket complete with plug	5	593LRP #

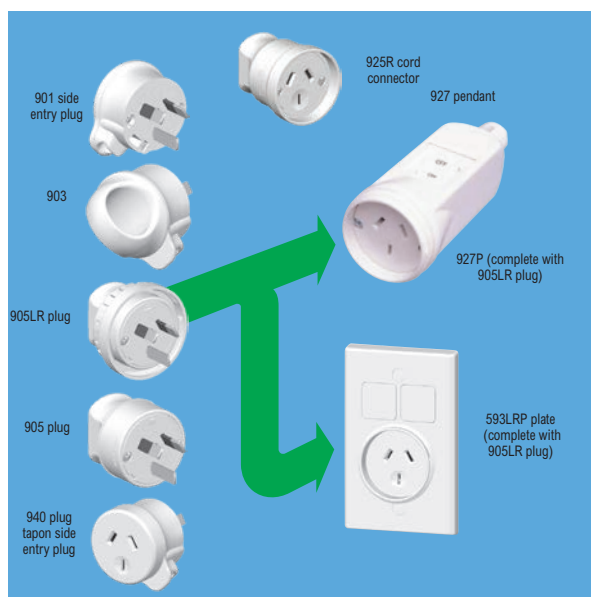

Available in White only.



154



155VNAR



157P



238



564/1J



593/15PP



593/30

Clipsal Mounting Accessories

Description	Ctn Qty	Item / Cat Number
Mounting Brackets		
Mounting wall board clip 1 gang	20	154
Metal mounting bracket with skew fixing nails. Suits Slimline® and other Clipsal standard plate accessories – horizontal	20	155NAR
Metal mounting bracket with skew fixing nails. Suits Slimline™ and other Clipsal standard plate accessories – vertical	20	155VNAR
Metal plaster mounted bracket to suit rendered plaster walls	20	155P
Wall Boxes – Plastic		
Flush box plastic	100	157P
Surface Enclosures		
Mounting box with 20mm end entries	10	238
Mounting box with 25mm end entries	5	238/25

Fasteners

Cable Clips in Jars		
Moulded Cable Clips with Hardened Drive Nails		
Cable clip to suit 0.75mm ² 2 core flat figure 8 flex – jar of 300	1	564/00J
Cable clip to suit 1mm ² /1.5mm ² 3 core & 2.5mm ² 2 core flat cable – jar of 150	1	564/0J
Cable clip to suit 2.5mm ² 3 core flat cable – jar of 100	1	564/1J
Cable clip to suit 4mm ² 3 core flat cable – jar of 70	1	564/2J
Cable clip to suit 6mm ² 3 core flat cable – jar of 70	1	564/3J
Strip Connectors		
12 terminal connector strip 500V 15A with pressure plates	10	593/15PP
12 terminal connector strip 500V 30A	20	593/30

Clipsal General Wiring Accessories

Description	Ctn Qty	Item / Cat Number
Junction Boxes		
Standard Junction Box 40A	10	554/4
Large Junction Box 40A	10	554J4
Large Junction Box Clip on Lid 40A	10	554C4



554/4

Pin Clips		
Brass Pin Clips in Boxes		
Pin clip size 1 – 38mm length – box of 200	10	564PC1
Pin clip size 2 – 45mm length – box of 200	10	564PC2
Pin clip size 3 – 51mm length – box of 200	10	564PC3
Pin clip size 4 – 57mm length – box of 200	10	564PC4
Pin clip size 5 – 67mm length – box of 200	10	564PC5



554J4



564PC2

Grommets and Cord Anchors

Moulded Cable Entry Grommets		
Wide Flange Type		
Inside diameter 8mm suits metal hole 9.5mm diameter	100	567/9.5
Inside diameter 9.5mm suits metal hole 12.7mm diameter	100	567/13
Inside diameter 12.7mm suits metal hole 16mm diameter	100	567/16
Inside diameter 16mm suits metal hole 19mm diameter	100	567/19
Inside diameter 16mm suits metal hole 20mm diameter	100	567/20
Inside diameter 19mm suits metal hole 22.2mm diameter	50	567/22
Inside diameter 22.2mm suits metal hole 25.5mm diameter	50	567/25.5
Inside diameter 28.5mm suits metal hole 31.8mm diameter	50	567/32



564PC4



567/13



BP567/22

Clipsal General Wiring Accessories



413QC-WE



438XHD-TR



438S15-WE



438S15HD-TR



438/20-WE

Description	Ctn Qty	Item / Cat Number
Socket Outlets – Surface Mount		
Surface Sockets		
<i>Available in White (WE) only.</i>		
Surface socket single 500V 10A 4 pin	10	410
Surface Socket Single 250V Quick Connect Terminals	10	413QC

Extension Sockets		
Rewirable Cord Extension Sockets		
<i>Available in White (WE) and Transparent (TR).</i>		
Socket PVC 10A suit 1mm ² ord.duty flex	10	438
Socket PVC 10A suit 1.5mm ² heavy duty flex	10	438XHD
Socket PVC 15A suits 1.5mm flex	10	438S15
Socket PVC 15A HD suits 1.5mm flex	10	438S15HD
Socket PVC 20A suit 2.5mm ² ord.duty flex	10	438/20

Clipsal General Wiring Accessories

Description	Ctn Qty	Item / Cat Number
Electric Clock Connection Accessories		
Clock point recessed socket 250V 5A 50Hz 3 pin	5	408/3
Clock point recessed socket 250V 5A 4 pin	5	408/4
Clock point plug 250V 5A 50Hz 3 pin	5	409/3
Clock point plug 250V 5A 50Hz 4 pin	5	409/4



408/3-WE



408/4-WE



SB1P2P

Cross Reference Clock Points		
Description	Plug	Socket
250V 5A 50Hz 3 pin	409/3	408/3
Suitable for other than 250V 50Hz 3 pin	409/3A	408/3A
250V 5A 50Hz 4 pin	409/4	408/4

Pop-up Socket	
Pop-up outlet double 250V 10A	SBIP2P *

Suspension Sockets	
<i>Available in Electric Orange (EO) and Grey (GY).</i>	

Suspension switched socket 250V 15A	5	SS15/15
-------------------------------------	---	---------



SS15

Socket Outlets – Standard Range	
Standard Size Mounting	

These items are available on indent order only.

Power outlet single 10A – single pole	5	10M
Power outlet single 15A – double pole with safety shutter	5	10MD15S



10M-WE

* Available in White (WE), Black (BK), Stainless Steel (SS)



1439S



439/4

Clipsal General Wiring Accessories

Description	Ctn Qty	Item / Cat Number
Plugs		
<i>Available in White (WE) and Transparent (TR).</i>		
Rewirable Plugs		
Extra safety plug side entry 10A	10	418S
Extra safety plug rigid 250V 10A suit 1mm ² ord.duty flex, 3 insulated pins	10	1439S *
Plug PVC 10A suit 075/1mm ² ord.duty, round earth pin	10	439SL #
Plug 500V 10A 4 pin suit 1mm ² 4 core ord.duty flex	10	439/4 #
Plug rigid 500V 10A 4 pin to suit 413/4P	10	1439/4P *
Plug PVC 10A suit 1.5mm ² heavy duty flex	10	439SXHD *
Plug rigid 20A suit 2.5mm ² heavy duty flex	10	1439/20 *
Plug PVC 15A suit 1.5mm ² heavy duty flex	10	439S15HD *

Cross Reference Plugs and Sockets

Description	Plug				Extention Socket			Surface Socket
	418S	439S	439SXHD	1439S	438	438XHD	1438	
3 pin 10amp	418S	439S	439SXHD	1439S	438	438XHD	1438	413 or 412
3 pin 10amp Round Earth	418SL	439SL			438L			PDL51R
3 pin 15amp	418S15	439S15	439S15HD	1439S15	438S15	438S15HD	1438/15	413/15
3 pin 20amp	1439/20				438/20			
2 Round 1 Flat Earth 10amp 110Volt	439/110				438/110			412/110
4 pin 10amp	439/4							410
4 pin 3 Flat 1 Round Earth 10amp	1439/4P							413/4P
2 parallel pins 10amp 125volt	492				438/2			402
2 pins T, 10amp, 32volt	492/32				438/32			402/32

Caravan/Camping Power Supply Fittings

Schneider Electric designs and manufactures a range of specialist protected accessories ideal for safe, efficient use of electrical products in outdoor situations. The range includes RCD protected cordsets for both camping and caravan sites.

Description	Ctn Qty	Item / Cat Number
Caravan/Camping Power Supply Fittings		
BALS CEE Plugs, Sockets & Accessories		
Caravan conversion kit (includes 211, 31240, 2638 and 1S055)	1	BALS098 *
Appliance inlet surface mounting 16A IP67	1	BALS2638
Adaptor plate (for above)	1	BALS1S055
Plug, 3 pin, 16A IP44	10	BALS211
Plug, 3 pin, 16A angled IP44	10	BALS231
Plug, 3 pin, 16A IP67	1	BALS21238
Connector, 3 pin, 16A, straight, IP67	1	BALS31240
Socket, panel mounting, 16A IP44	1	BALS1217
Extension lead, 10m with 211 and 31240	1	BALS812 *



BALS31240



BALS2638



BALS812



* Suitable for use with caravans registered prior to 1 July 1998 and/or 1 January 2003**.



56S0316/240



56CV316/240



56C316RCD30

Caravan/Camping Power Supply Fittings

Description	Ctn Qty	Item / Cat Number
56 Series™		
Socket switched, 16A IP66	2	56CV316/240 ^
Socket unswitched, 16A IP66	4	56S0316/240 ^
Socket, earth leakage, 30mA, 16A IP66	2	56C316RCD30 ^
DIN mount MCB/RCD cover 1 to 4 pole width, IP66	4	56CB4
Surface Enclosures		
Circuit breaker cover 1 or 2 way	1	SE2
Circuit breaker cover 1 to 4 way	1	SE4
MCB 6kA C Curve		
Circuit breaker 16A S.P. Domae	12	DOM11377
RCD/MCB (RCBO)		
RCBO, 30mA, 16A, 6kA, two pole	6	DOM19803
Slim RCBO (18mm), 30mA, 16A, 6kA, two pole	12	DOM12531

^ Compatible with BALS 211 and BALS 21238 plugs.

Final Distribution

Description	Ctn Qty	Item / Cat Number
Cable Connection Accessories		
Bars, Links, and Strip Connectors		
500V 140A 4 hole Active link red – T type 25mm ²	10	L4T35R
500V 80A 4 hole link black – 2 screws all tunnels 25mm ²	10	BPT2
75A, heavy duty strip connector, 12 terminal	15	BP365N
Insulated Busbars and Supports		
Busbar supports:		
Large adjustable support	100	3040
Small nonadjustable support	100	3041
Large adjustable	100	3042
Mains Entry Boxes		
1 terminal mains entry kit	10	847/1
2 terminal mains entry kit	10	847/2
3 terminal mains entry kit	10	847/3
4 terminal mains entry kit	10	847/4
Shroud	10	848
Rear mains entry kit	10	849



L4T35R



BPT2



BP365N



3040

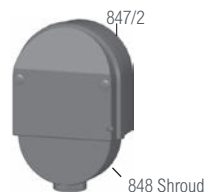

848 Shroud



Weather Protected Series



PDL WP Series

Description	Ctn Qty	Item / Cat Number
Switches		
Switches, 250V, IP56, less enclosure		
Single switch (20A), suits WE1 or WE1S	6	WSW201LEGY
Double switch (20A), suits WE1 or WE1S	6	WSW202LEGY
Single switch (32A), suits WE1	6	WSW321LEGY
Socket Outlets		
Switched Sockets IP53, less enclosure		
Single socket (10A), suits WE1 or WE1S	6	WSO310LEGY
Single socket (15A), suits WE1 or WE1S	6	WSO315LEGY
Double socket (10A), suits WE2 or WE2S	4	WSO310/2LEGY
Single socket (10A) with extra switch (20A), suits WE2 or WE2S	4	WSO310XLEGY
Junction Boxes IP56, with enclosure		
Single Junction Box	6	WJ1GY
Double Junction Box	6	WJ2GY
Enclosures		
Size 1 Deep (standard), 38mm deep	6	WE1GY
Size 1 Shallow, 20mm deep	10	WE1SGY
Size 2 Deep (standard), 38mm deep	4	WE2GY
Size 2 Shallow, 20mm deep	6	WE2SGY
Reducer PVC plain 25/20mm screw	50	222/2M-GY
Sunset Switch, IP56, with enclosure		
Weather protected sunset switch, IP56, 10AX, Dusk to Dawn or Dusk plus 2, 4, 6, 8 Hour adjustable timer with adjustable light level sensitivity.	6	WDL10



WSW201LEGY and WSW321LEGY



WSW202LEGY



WSO310LEGY



WSO310/2LEGY



WSO310XLEGY



WJ1GY

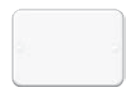

WJ2GY



WE1GY



WE1SGY



WE2GY



222/2M-GY



WDL10



PDL S Series



S340EM

Description	Ctn Qty	Item / Cat Number
Surface Switches		
IP66 Isolators with surface mounting enclosure 		
Single Pole 20A	1	S120EM
Single Pole 32A	1	S132EM
Double Pole 20A	1	S220EM
Triple Pole 20A	1	S320EM
Triple Pole 32A	1	S332EM
Triple Pole 40A	1	S340EM
Triple Pole 63A	1	S363EM

Clipsal Weathershield® Series

Description	Ctn Qty	Item / Cat Number
Surface Switches		
WHA Series – IP66		
Switch 250V 20A single pole	1	WHA120
WHB Series – IP66 Isolators 		
Switch 250V 20A single pole	1	WHB120
Switch 440V 20A triple pole	1	WHB320
Switch 500V 20A four pole	1	WHB420
Switch 250V 40A single pole	1	WHB140
Switch 440V 40A triple pole	1	WHB340
WHC Series – IP66 Isolators 		
Switch 500V 63A triple pole	1	WHC363/40
Switch 500V 80A triple pole	1	WHC380
Switch 500V 80A four pole	1	WHC480
WS Series – IP66		
Switch 1 gang 250V 15A square	1	WS226
Switch 1 gang 250V 10A square double pole	1	WS226D
Switch 1 gang 250V 10A square intermediate	1	WS226I
Switch 2 gang 250V 15A	1	WS226/2
Switch 1 gang 250V 20A square	1	WS226/20
Switch 1 gang 440V 10A Push-Button station	1	WS226PB
Switch 2 gang 440V 10A IP66 marked STOP and START	1	WS226/2PB
Switch 250V 15A 1 way/2 way IP66 surface mounting with 20mm entry	5	WS229
1 gang enclosure to suit 30 series mechanisms	5	WS229VH
Flush Switches		
Switch 1 gang 250V 15A standard size IP54	1	WSF226
Switch 2 gang 250V 15A standard size IP54	1	WSF226/2
Switch 3 gang 250V 15A standard size IP54	1	WSF226/3



WHA120



WHB320



WHC380



WS226



WS226/2



WS226/2PB



WS229



WSF226/3



WSR226

Clipsal Weathershield® Series



WSCF227/2



WSCF227F2



WSCF228



WSC227/1



WSC227/2



WSC227



WSC227F2



WSF226E2

Description	Ctn Qty	Item / Cat Number
Switch 1 gang 250V 15A round IP54	5	WSR226

Flush Mount IP53

Power outlet single 250V 10A	1	WSCF227/1
Power outlet double 250V 10A	1	WSCF227/2

With Hinged Flap – IP54

Power outlet double 250V 10A	1	WSCF227F2
Power outlet single 250V 10A	1	WSCF228

Surface Mount IP53

Power outlet single 250V 10A	1	WSC227
Power outlet single 250V 10A standard size	1	WSC227/1
Power outlet single 250V 15A	1	WSC227/15
Power outlet single 250V 15A standard size	1	WSC227/1/15
Power outlet double 250V 10A standard size	1	WSC227/2
Power outlet double 250V 10A standard size with extra switch	1	WSC227/2X
Power outlet double 250V 15A standard size	1	WSC227/2/15

With Hinge Flap – IP54

Power outlet single 250V 10A standard size	1	WSC227F1
Power outlet double 250V 10A standard size	1	WSC227F2
Power outlet single 250V 10A with hinged flap - IP54	1	WSC228

Weathershield Accessories

LED kit suits WS and WH series	1	56LEDK1
--------------------------------	---	---------

Notes



LED Lighting, Sensors & Smoke Alarms



PDL Lighting Accessories

Description	Ctn Qty	Item / Cat Number
Lampholders		
Batten Holders, Bayonet Cap		
Angled batten holder 150W max	20	28L #
Batten holder 150W max	20	29L
Batten holder with clip-on cover, 150W	10	629 #
Lampholder Spares and Accessories		
Ceiling rose, 5A, 4 terminal	20	44 *
Ceiling rose, 16A, 4 terminal	10	44A #
Shade conical 230mm, 150W max	50	49 #
Lampholders		
Unswitched, Bayonet Cap		
150W rated large term	20	26 #
1/2" female thread	20	30A #
3/8" female thread	20	30B #
5/16" female thread	20	30C #



Available in White only.

PDL Lighting Accessories



56SS10



WDL10

Description	Ctn Qty	Item / Cat Number
-------------	---------	-------------------

Sunset Switches

56 Series – Universal vertical or horizontal mounting. IP66 weather protection, adjustable time and sensitivity settings.

Without enclosure, 10A 250V	4	56SS10
-----------------------------	---	--------

With enclosure, 10A 250V	4	56SS10WE
--------------------------	---	----------

WP Series – Universal vertical or horizontal mounting. IP56 weather protection, adjustable time and sensitivity settings.

With enclosure, 10A 250V	6	WDL10
--------------------------	---	-------

Clipsal Lighting Accessories

Description	Ctn Qty	Item / Cat Number
Battenholders		
Battenholder BC straight with clip-on cover	10	2530
Adjustable BC battenholder	10	535
Lighting Accessories		
Lampholders		
Lampholder BC with cord grip and safety skirt	10	501
Lampholder ES with cord grip and safety skirt	10	501ES
Skirt only – old 502 skirt only suits BC lampholder	100	501SK
Lampholder BC 2 pin with looping terminal – 100W max	10	516
Ceiling Roses		
Ceiling rose – 5 terminal	5	935
Ceiling rose	10	93



2530



535ES



501



CLITPFLS10LED



CLITPFLS20SENLED

LED Lighting

Description	Ctn Qty	Item / Cat Number
9W LED Downlights 90mm Cut Out		
9W, Tri Colour LED IP44	1	CLITPDL1C2
Black Trim for CLIPDL1C2 CLITPDL1T2C BK	1	CLITPDL1T2CBC
9W 3000k 950lm	1	CLITPDL2K3
9W 4000K 950lm	1	CLITPDL2K4
Slim LED Flood Lights		
10W LED Flood Light	1	CLITPFLS10LED
20W LED Flood Light	1	CLITPFLS20LED
50W LED Flood Light	1	CLITPFLS50LED
20W LED Flood Light with PIR Sensor	1	CLITPFLS20SENLED
LED Bulkheads		
LED IP54 Bulkhead Rectangle 1100lm	1	CLITPBHS2
LED IP54 Bulkhead Round 1100lm	1	CLITPBHS1

Smoke Alarms

Description	Ctn Qty	Item / Cat Number
Smoke Alarms - Photoelectric		
250V Smoke Alarm Surface Mount	1	755PSMA4
250V Smoke Alarm Lithium Battery	1	755RLPSMA4
Relay Base for 230V Smoke Alarm	1	755RB
W/less Base for 230V Smoke Alarm	1	755RFB2
250V Flush Mount Smoke Alarm	1	755PFM4



755PSMA4

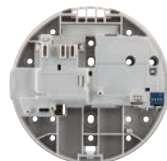

755RFB2



100MPIR



100SA360

PDL Sensors

Indoor Applications

600, 800 Series modular PIR	1	100MPIR
Iconic PIR Sensor	1	352MPIR

Outdoor Applications

Wall, soffit, corner or conduit mounting sensor with a 360° field of view, IP55	1	100SA360
---	---	----------

Clipsal Sensors

Motion Detectors

Passive Infrared Sensors

Infrascan® mounting base adaptor	1	750MBA
Passive infrared detector 250V 2A 2 wire – indoor model (non-weatherproof)	1	751
Passive infrared detector 250V 10A 3 wire – indoor model (non-weatherproof)	1	751R
Mounting base for 751, 751R and 5751	10	751MB

Passive Infrared Sensors – 360°

Infrascan® 250V 2A 2 wire – flush mount 360°	1	753
Infrascan® 250V 10A 3 wire – flush mount 360°	1	753R



750WPR-GY



751R-WE



753



SAE_UE_MS_CSAWE



SAE_UE_MS_CDBWE



CCT551011



CCT556011

Argus Sensors

Description	Ctn Qty	Item / Cat Number
Occupancy Sensor Range – Argus Series		
Ceiling Mount 360° single load PIR Sensor	1	SAE_UE_MS_CSAWE
Ceiling Mount 360° Dual load PIR Sensor	1	SAE_UE_MS_CDBWE
Ceiling Mount 360° Dual Tech Sensor	1	CCT551011
Remote for Dual load PIR sensor	1	SAE_UE_MS_1R_WE
Remote for Dual Tech Sensor	1	CCT556011

Leveraging state-of-the-art Infrared, or Dual Technologies, Schneider Electric's ultra-sensitive Argus Occupancy Sensors offer you the ultimate in reliable, efficient and cost-effective indoor lighting control.

- > Suitable for most residential and commercial applications to control incandescent, halogen, fluorescent and CFL lamps
- > Dual-technology sensors are more sensitive towards smaller movements, ideal for office buildings
- > Infrared remote controllers are available to simply program the sensors

Notes

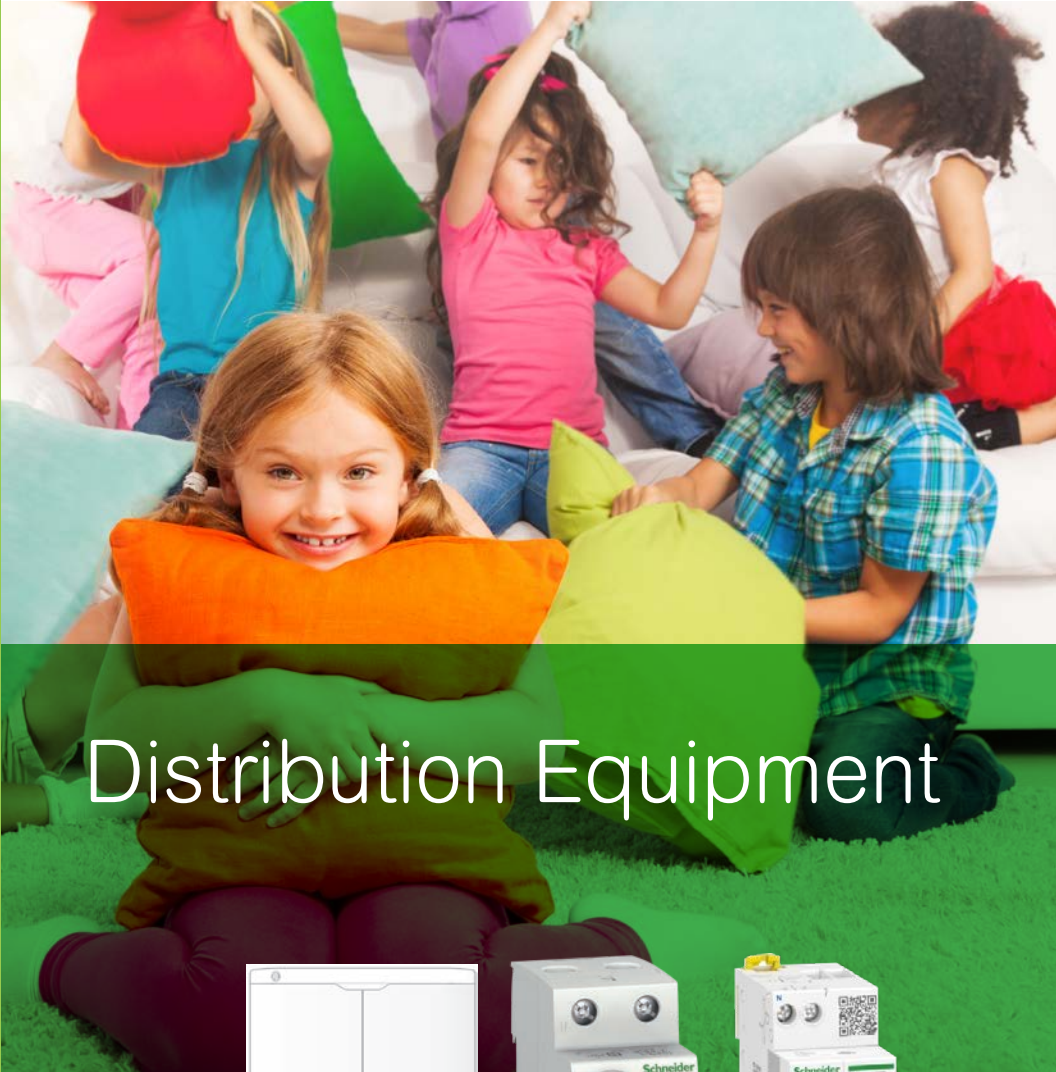

Distribution Equipment

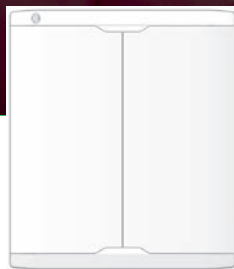

45 and 60 way

BIGGER BOARDS

- More wiring space
- 58mm more room top and bottom
- Effectively double the amount of space

EXTRA WIRING ROOM

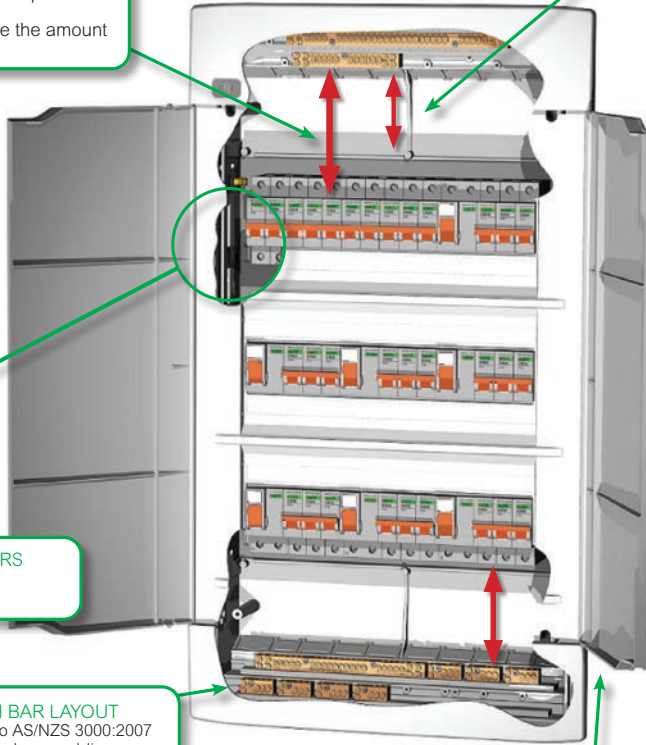

CABLE TIE ANCHORS

- Built into the base

NEUTRAL & EARTH BAR LAYOUT

- Improved and suited to AS/NZS 3000:2007
- Numbering engraved on mouldings

Note: the above image has sections removed for illustrative purposes.

Additional Improvements Included:

IMPROVED CIRCUIT ID LABELS

Updated to suit today's requirements

ACCESSORY PACKS

N&E Links included

DBF FLANGE INSTRUCTIONS

Permanently added to indicate use for flush mounting or retrofit

Switchboards



DBF15



DBS15



DBF30BPDOM



56CB4WHITE



MIP0108S



SE6

Description	Ctn Qty	Item / Cat Number
-------------	---------	-------------------

Flush Mounting Superboard Series – DBF

10 way	1	DBF10
15 way	1	DBF15
30 way	1	DBF30
45 way	1	DBF45
60 way	1	DBF60
30 way bundle pack Domae 40A	1	DBF30BPDOM #

DBF30BPDOM contains: 1xDBF30, 3x40A RCCBs, 7x20A MCBs, 2x10A MCBs

Surface Mounting Superboard Series – DBS

15 way	1	DBS15
30 way	1	DBS30
45 way	1	DBS45
60 way	1	DBS60

IP66 Surface Mounting

13 way fully equipped board, includes enclosure, DIN rail, N + E bars and links	1	56CB13*
4 pole width cover including DIN rail. 2 gang cover for mounting on standard 56E2 or larger enclosure. (Enclosure not included)	4	56CB4*

Surface Mounting, Mini Pragma Series

6 way	1	MIP0106S
8 way	1	MIP0108S
12 way	1	MIP0112S

Surface Enclosures

1 to 2 way	1	SE2
1 to 4 way	1	SE4
1 to 6 way	1	SE6

Containing Domae circuit protection.
*RO and RW priced 5% more than standard GY.

Switchboards

Description	Ctn Qty	Item / Cat Number
Builders Supply Box / Temporary Supply Board		
<i>Complies with AS/NZS3012 requirements</i>		
Builders supply enclosure	1	230DRAQTPL
Spare Parts for Switchboards		
Pole filler 7.5 length strip	1	DBF15/Z3
Phase bar	10	MG15
Neutral bar spare 4 way	1	DBFN4
Neutral/Earth bar spare 9 way	1	DBFNE9
Earthing conductor tag	100	4DBE
DBF & DBS Label sheet	1	DBF15/19
Door assembly 15 way	1	DBF15ASSY
Door assembly 30 way	1	DBF30ASSY
Door assembly 45 way	1	DBF45ASSY
Door assembly 45 way new type – large	1	DBF45ASSYNT
Door assembly 60 way	1	DBF60ASSY
Door assembly 60 way new type – large	1	DBF60ASSYNT
Power meter mounting kit – 45 and 60 way	1	DBFPMK
Superboard Flush Mount Spacer Kit		
<i>Suitable for mounting boards into walls as slim as 64mm</i>		
Spacer kit for DBF15	1	4FCC15SK
DIN Rail Mount Socket Outlets		
Front switched 72mm (4 pole) width		
Double pole, 250V 10A switched socket	1	4SSO15D
Double pole, 250V 15A switched socket	1	4SSO15D15
Internal switched 45mm (2.5 pole) width		
Single pole, 250V 10A switched socket	1	4PSO10
Double pole, 250V 10A switched socket	1	4PSO10D



230DRAQTPL



DBFPMK metering kit fitted in a DBF45 board



4PSO10D



Offer your customers the best protection from electrical fires



Arc Fault Detection Device (AFDD + RCBO) – an easy to install, cost effective solution to help keep your customers safe from electrical fires caused by arc faults.

Applications

Suitable for both new builds and retrofit.
 Conforms to standard: IEC 62606

Electrical arc fault detection and fire prevention through installation in DIN rail mounted electrical panels for a wide variety of circuits including:

- Socket circuits
- Lighting circuits
- Circuits with junction boxes
- Circuits in harsh environments (such as moisture, heat, UV, rodents, vibration)
- Ageing cables and connections.

	MCB	RCBO	AFDD
Overload/short circuit	✔	✔	✔
Direct/indirect contact		✔	✔
Arc to earth fault		✔	✔
Arc faults Series Arc fault			✔
Parallel Arc fault			✔
Overvoltage			✔

EV B type Earth Leakage Protection

Choosing the correct RCD type for the application is critical

Electric vehicles are becoming increasingly popular, and charging stations need the appropriate protection for all users. Especially given that these stations are often located outside where they are exposed to the rain and operated daily by untrained users.

For Electric Vehicle Charging Type B Earth Leakage Protection is what you need to provide Safe and Efficient People Protection.



A9Z51216



Model iID

RCCB for EV

DESCRIPTION	CTN QTY	ITEM / CAT NUMBER
16A 2 poles 30mA	1	A9Z51216
25A 2 poles 30mA	1	A9Z51225
40A 2 poles 30mA	1	A9Z51240
40A 4 poles 30mA	1	A9Z51440
63A 4 poles 30mA	1	A9Z51463

Protection device kits

Description	Ctn Qty	Item / Cat Number
Protection devices kit for 7.4 kW EVlink Wallbox and Smart Wallbox	1	KITWALLBOX7
Protection devices kit for 11/22.1 kW EVlink Wallbox and Smart Wallbox	1	KITWALLBOX22

Note: Depending on the reference, each kit would have an MCB and RCD (or RCBO), and under-voltage release

Horizontal comb busbar for 18mm pitch



A9XPH112



A9X21095



Description	Ctn Qty	Item / Cat Number
Standard comb busbar 100A L1... 12 Modules of 18mm	1	A9XPH112
Standard comb busbar 100A L1... 24 Modules of 18mm	1	A9XPH124
End caps 1P+N	40	A9X21094
Insulated tooth caps	20	A9XPT620
Insulated connector (up to 16mm cable)	4	A9XPC604

Horizontal comb busbar for 9mm pitch



Description	Ctn Qty	Item / Cat Number
Standard comb busbar 80A, compatible with iDPN/iDPN Vigi and iSPN product		
Top feed 1P + N, 12 modules of 18mm	1	A9XPC612
Top feed 1P + N, 24 modules of 18mm	1	A9XPC624
Bottom feed 1P + N, 12 modules of 18mm	1	A9XPH612
Bottom feed 1P + N, 24 modules of 18mm	1	A9XPH624
End caps 1P	10	A9XPE110
Insulated tooth caps	20	A9XPT920
Insulated connector (up to 35mm cable)	4	A9XPCM04

Final Distribution

Description	Ctn Qty	Item / Cat Number
Domae Switch Disconnecter		
63A 1P Domae	12	DCK12458
63A 2P Domae	6	DCK12461
63A 3P Domae	4	DCK12464
100A 1P Acti9	12	A9S66191
100A 2P Acti9	6	A9S66291
100A 3P Acti9	4	A9S66391
Domae Circuit Breaker		
6A 1P 6kA C Curve	12	DOM11375
10A 1P 6kA C Curve	12	DOM11376
16A 1P 6kA C Curve	12	DOM11377
20A 1P 6kA C Curve	12	DOM11378
25A 1P 6kA C Curve	12	DOM11379
32A 1P 6kA C Curve	12	DOM11380
40A 1P 6kA C Curve	12	DOM11381
RCDs		
<i>Neutral is switched for all Domae RCDs</i>		
Domae RCCB		
30mA 2P 40A	6	DOM16695 ^
30mA 2P 63A	6	DOM16696 ^
Domae Slimline RCBO range		
<i>Single pole width (18mm), double pole switching</i>		
AD63 K C 6A 1PN 30mA 6kA RCBO	12	DOM12529
AD63 K C 10A 1PN 30mA 6kA RCBO	12	DOM12530
AD63 K C 16A 1PN 30mA 6kA RCBO	12	DOM12531
AD63 K C 20A 1PN 30mA 6kA RCBO	12	DOM12532
AD63 K C 25A 1PN 30mA 6kA RCBO	12	DOM12533
AD63 K C 32A 1PN 30mA 6kA RCBO	12	DOM12534



DCK12461



A9S66191



DOM11378



DOM16695



DOM12529

^ For wiring options refer to section O.

Final Distribution



DOM19803



A9T26620



15335



16693



A9MEM2000



A9M17067

Description	Ctn Qty	Item / Cat Number				
Domae RCBO						
30mA 10A, 6kA	6	DOM19802 *				
30mA 16A, 6kA	6	DOM19803 *				
30mA 20A, 6kA	6	DOM19804 *				
30mA 25A, 6kA	6	DOM19805 *				
30mA 32A, 6kA	6	DOM19806 *				
30mA 40A, 6kA	6	DOM19807 *				
Arc Fault Detection Devices (AFDD) + RCBO						
iDPN N VigiARC C 6A 6000A 30mA Type A		A9T26606 #				
iDPN N VigiARC C 10A 6000A 30mA Type A		A9T26610 #				
iDPN N VigiARC C 16A 6000A 30mA Type A		A9T26616 #				
iDPN N VigiARC C 20A 6000A 30mA Type A		A9T26620 #				
iDPN N VigiARC C 25A 6000A 30mA Type A		A9T26625 #				
Time Switches, Single Pole						
24 hour analogue	1	15335				
24 hour/7 day digital	1	CCT15838				
Surge Protection (Type 2 Fixed cartridge)						
Model	No of Poles	I _{max}	U _n (V)	U _p kV	Width in mod. of 9mm	Cat. No.
Quick PF10	1+N	10kA	230	1.5	4	16693 *
Contactors/Relays						
CT 2NO 25A		12	A9C20732 *			
Impulse Relay 16A 1NO		12	A9C30811			
Impulse Relay 16A 2NO		12	A9C30812			
Energy (kWh) Meters						
iEM2000 40A kWh meter		1	A9MEM2000			
iEM2010 40A 1P kWh meter Pulse Output		1	A9MEM2010			
iEM1 63A 1P kWh meter		1	A9M17065			
iEM1zr 63A 1P kWh meter Pulse Output		1	A9M17067			

*For wiring options refer to section O

#Has a built in 6kA circuit breaker for isolation and protection.

*For more Final Distribution products and the Acti 9 range please refer to Section C of the Schneider Electric A4 Price Catalogue.

Final Distribution

Description	Ctn Qty	Item / Cat Number
Panel Mount Mains Switches		
Surface Mounting Main Switches – S Series		
S.P. 80A back wiring	10	S180BW
S.P. 80A front wiring	10	S180FW
D.P. 80A back wiring	5	S280BW
D.P. 80A front wiring	5	S280FW
T.P. 80A back wiring	5	S380BW
T.P. 80A front wiring	5	S380FW



S180BW



S280BW



S380BW

Panel Mount Mains Switches – Clipsal		
Single Pole		
35A panel mounting single pole back wiring	10	PS35
55A panel mounting single pole back wiring	10	PS55
80A panel mounting single pole back wiring	10	PS80
80A panel mounting single pole front wiring	10	PS80F
Triple Pole		
80A panel mounting triple pole back wiring	5	PT80
80A panel mounting triple pole front wiring	5	PT80F

Testing and Monitoring Equipment



For a demonstration or instruction on how the Spark-e-mate works and can be used watch the Spark-e-mate 493BTL Instructional Video on YouTube

Description	Ctn Qty	Item / Cat Number
Installation Testing Equipment		
Installation testing made easy, with the new Spark-e-mate from Schneider Electric.		
Spark-e-mate Multi-Function Tester: Earth, Insulation, Circuit, RCD, Voltage, Frequency – 240V 50Hz	1	493
Spark-e-mate Multi-Function Tester with Bluetooth (compatible with Android)	1	493BTL
Spark-e-mate Multi-Function Tester with Bluetooth (compatible with iOS)	1	493BTLI
Spark-e-mate Meter Leads	1	493L
Spark-e-mate Meter Shoulder bag	1	493SB

Spark-e-mate Calibration Service [#]

[Spark-e-log Android app*](#) available for free in the Google Play store, search for Sparkelog.

[#] Contact customer care for details.

* iPhone app coming soon.

< Spark-e-log app compatible with 493BTL Spark-e-mate testers and Bluetooth enabled smart phones.

Notes

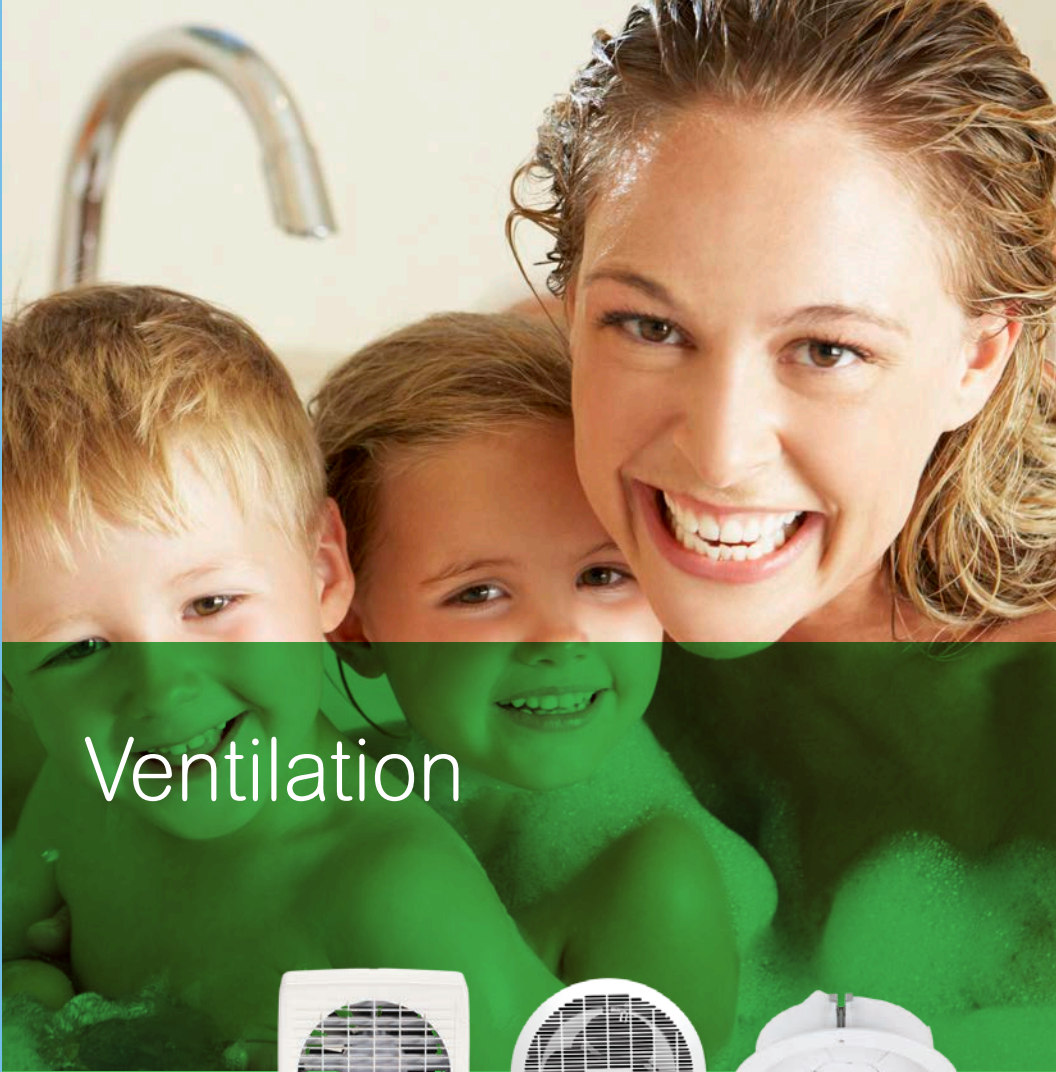

Ventilation



Ventilation

Description	Ctn Qty	Item / Cat Number
Airflow Window and Wall Exhaust Fans		
150mm Window/Wall Exhaust Fans		
MaxAir window, switched remotely, auto louvres, IPX4, 45W, 213mm diameter cut out, 360 m³/hr	1	7005A *
MaxAir wall, switched remotely, auto louvres, IPX4, 45W, 180mm diameter cut out, 360m³/hr	1	7006A *
200mm Window/Wall Exhaust Fans		
MaxAir window, auto switched louvres, IPX4, 38W, 230mm diameter cut out, 600 m³/hr	1	7105A *
MaxAir wall, auto switched louvres, IPX4, 38W, 230mm diameter cut out, 600m³/hr	1	7106A *
MaxAir window, pull cord switched louvres, IPX4, 38W, 230mm diameter cut out, 600m³/hr	1	7107A *
MaxAir wall, pull cord switched louvres, IPX4, 38W, 230mm diameter cut out, 600m³/hr	1	7108A *
Wall Plate For Replacement of Airflow Wall Exhaust Fans		
Wall plate to cover cutting errors for 7100 Series MaxAir fans (200mm) or to assist the replacement of older style Airflow or Mistral window/wall fans.	1	7100WP *
Ceiling Exhaust Fans		
Airflow Ceiling Exhaust Fans		
All Airflow Exhaust Fans are supplied with Ball-bearing Motors		
200mm, flex and plug, 240mm diameter cut out, 260m³/h	6	CE200 *
250mm, flex and plug, 287mm diameter cut out, 385m³/h	6	CE250 *
Clipsal Airflow Ceiling Exhaust Fans		
Expressaire 254mm, auto retract blades, flex and plug, 290mm diameter cut out, 800m³/hr	1	6220-0 *



7106A



7100WP



CE200



6220-0

* Available in White only.

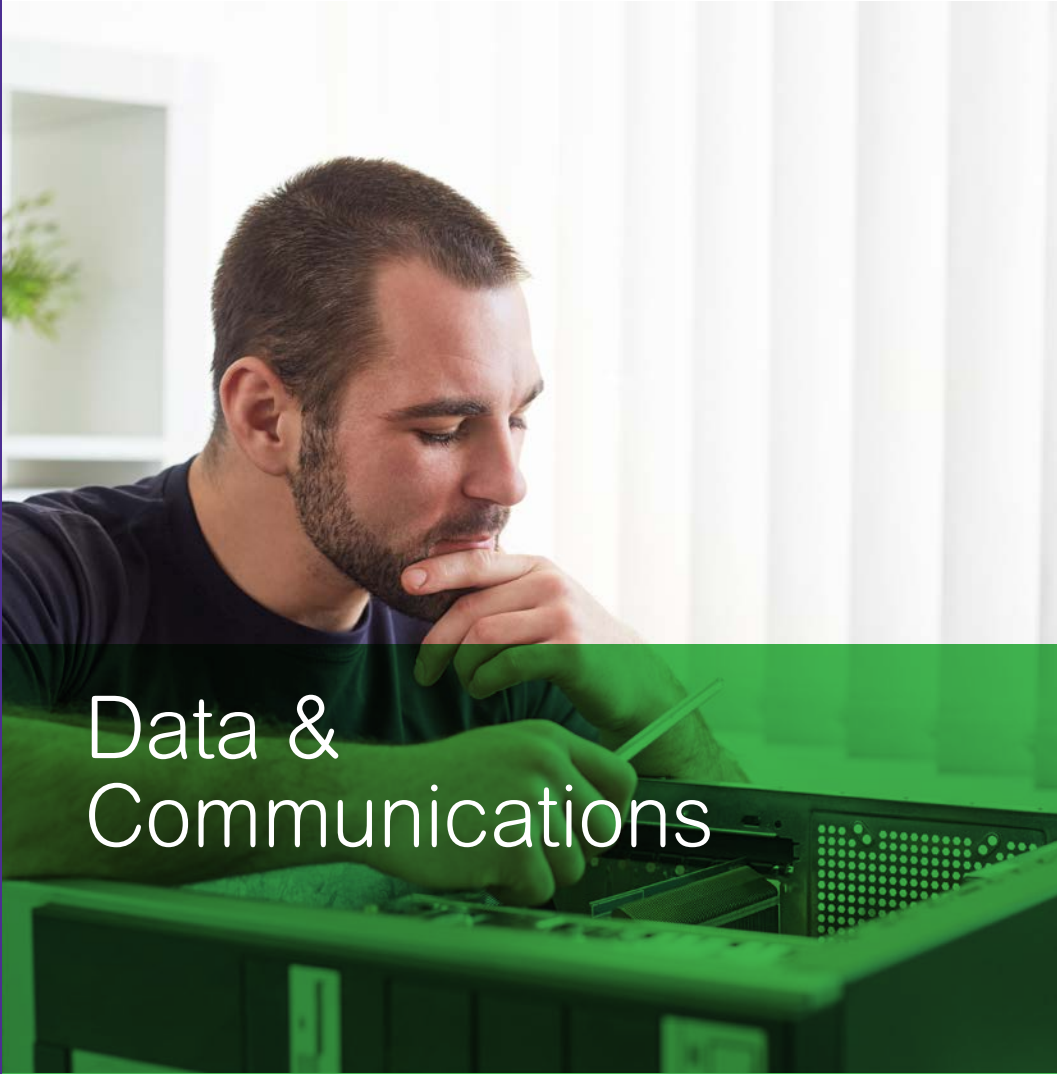

Data & Communications

Your end-to-end solution starts here...

With the demands on data communication products increasing every day, Schneider Electric is committed to developing innovative, quality products and technologies to meet your needs. Encompassing solutions ranging from active networking products to Cat6 and connectivity products, the Actassi data range from Schneider Electric provides high quality and comprehensive networking solutions to cater for all the requirements of both installers and end users alike. Actassi range of structured cabling products.

- RJ45 solutions
- Category 6 products
- Category 6A products
- Fibre Cable
- Trays

Patch Panels and Associated Accessories



ACTPP6U24NSS



RJ6AF/24PP



CPLRJ24USPPAN



RJ6AU24PPC



ACTRJ1UCMPM

Description	Ctn Qty	Item / Cat Number
Patch Panels		
Category 6		
Category6, UTP 24-port Non-Shutter Patch Panel, Loaded	1	ACTPP6U24NSS
Category 6A FTP		
Cat6A FTP 24-port patch panel, loaded	1	RJ6AF/24PP
Cat 6A Patch Panel Angled 24 Port Shielded, Unloaded	1	CPLRJ24USPPAN
Category 6A UTP		
Cat 6A UTP 24-port patch panel loaded	1	RJ6AU24PPC
Cable Management Products		
Panel 1RU deep cable management ring run with cover	1	ACTRJ1UCMPM

*White (WE) Standard colour other colours are indent only.

Data and Voice Connection Accessories

Description	Ctn Qty	Item / Cat Number
Connector Mechanisms		
Category 6 Connector Mechanisms		
Actassi S-110 Connector RJ45 300 Series Unshielded Cat6 Shutter Translucent	1	VDIB17396UTN
Actassi S-110 Connector RJ45 Keystone Unshielded Cat6 Shutter White	1	VDIB17346UWE
RJ45 Jack CAT6 UTP 30M	1	30RJ45SMA6C-WE
Actassi S-110 Connector RJ45 Keystone Unshielded Cat6 White	1	VDIB17366UWE
Actassi S-110 Connector RJ45 300 Series Unshielded Cat6 Translucent	1	VDIB17386UTN
Category 6A UTP Connector Mechanisms		
RJ45 Jack CAT6A UTP Keystone	1	RJ45SMA6AC
Actassi S-110 Connector RJ45 Keystone Unshielded Cat6A White	1	VDIB1736XUWE
Actassi S-110 Connector RJ45 Keystone Unshielded Cat6A Shutter White	1	VDIB1734XUWE
Actassi S-110 Connector RJ45 300 Series Unshielded Cat6A Translucent	1	VDIB1738XUTN
Category 6A FTP Connector Mechanisms		
Non-shutter modular jack, Cat6A FTP keystone, metal	1	ACTRJSMTG6ANSS
Non-shuttered 30 series Jack, Cat6A FTP metal	1	30RJ45SM6AF
Actassi - modular jack - category 6A - 10G - FTP - non shuttered - panel version	1	ACTRJSMTG6ANSSP
Installation Tools		
Actassi - quick termination tool for S110 punchdown connectors	1	VDIB2736



VDIB17396UTN



VDIB17366UWE



VDIB17386UTN



VDIB1734XUWE



ACTRJSMTG6ANSS



VDIB2736

*White (WE) Standard colour other colours are indent only.

Cable



2D4P6IPV3B-BU



ACTTG4P6ASC3RBU



ACTTG4P6AUCM3RBU

Description	Ctn Qty	Item / Cat Number
LAN Cable		
Category 6 UTP LAN Cable		
CAT6 4PR UTP CABLE 305M PE GEL REEL BK- Outdoor	1	ACT4P6UPEJ3RBK
4 pair unshielded UTP Cat6 LAN cable, 305m box	1	2D4P6IPV3B-BU
Category 6A F/UTP LAN Cable		
CAT 6A 10G UTP CABLE 305M BLUE, CM	1	ACTTG4P6AUCM3RBU
4 Pair Cat6A FTP Cable 305m box	1	ACTTG4P6ASC3RBU

Actassi Fibre Series

Description	Ctn Qty	Item / Cat Number
Fibre Cable		
Fibre Cable 6 Core OM3	1000	SNZ5428377
Cut OM3 12 Core Fibre Multimode	1000	SNZ5424010CUT

Fibre Adaptors		
High Density Fiber Panel and Accessories		
Enclosure fibre 1RU unloaded max 24 connectors	1	ACTMP1U
Adaptor panel blank connector sector panel	1	ACTMPBP
Adaptor panel LC duplex panel C/W 6 connectors	1	ACTFM1UF2LC6PMM
Fusion Splice Tray Kit	1	ACTFMSPTKIT



ACTMP1U



ACTMPBP



ACTFMSPTKIT

Actassi Optimum



VDICD68X218



VDIG011241F



VDIG321241B



VDIB177AXB10TN



VDIB1771XB12

Description	Ctn Qty	Item / Cat Number
Cable		
Cab LAN MX FFTP 4P CAT6A LSZH 500m		VDICD68X218
Patch Panels and Accessories		
Slid panel basic 19 1U empty DPM FTP STP		VDIG011241F
Pan flat 19P 1U 24PT ANG S-ONE DPM STP		VDIG321241B
Modular Jacks		
Connector RJ45 CAT6A s-one 300 series stp		VDIB177AXB10TN
Connector RJ45 CAT6A s-one 300 series utp		VDIB177AXU10TN
30M adaptor white elec s-one dpm (12pcs)		VDIB27730MWE
Connector RJ45 CAT6A shielded dpm		VDIB1771XB12
Connector RJ45 CAT6A unshielded dpm		VDIB1771XU12

Notes



Integrated Systems



Simple Control Solutions

Smart Home Solution

The idea of having a smart home is exciting; however it can be confusing to know where to start and what it all really means. C-Bus Pre-programmed Pack home solution can provide a simplistic intelligent and automated operation of lighting and electrical devices throughout your home. A smart home enhances everyday lifestyle and allows your customer to take control of their home electrical system to suit their needs and budget. The C-Bus Pre-programmed Pack offers an easy to use lighting control system for your customers' home with set functions already programmed. It also provides them the power to set their own scenes for their home at the touch of a button. The idea around the C-Bus Pre-Programmed Pack is simple, with smart features that ANYONE can use. One of the most used features of C-Bus System is the 'All OFF' function. Another is customised scenes to switch multiple lights and the touch of ONE button. All C-Bus pre-programmed packs must be installed by a Schneider Electric Approved Installer or a New Zealand registered electrician.

DALIcontrol

Simple Solution

In today's world of digital lighting, DALI is regarded as the worldwide standard for control of commercial light fittings. The DALIcontrol 30 Mechs and Software, are suitable for a wide range of control functions in a commercial environment. Consider this, your customer wants to be able to control lighting in a large open plan office area. They need the installation completed as part of the base build, across multiple levels in the building. They are unsure of the final layout of each level, but know that they need multiple switch groups, and different zones of lighting. This can be achieved simply and efficiently with Clipsals DALIcontrol Simple Solution, incorporating an extended range of 30 Series mechanisms including DALI Simple Wizard Software.

C-Bus Input Units



5085EDLB-PW



50842NL



R5043NL-ZW



5041NMML



5000ETP10W

Description	Ctn Qty	Item / Cat Number
eDLT		
5 Key Input eDLT Glass Fascia Espresso Black		5085EDLB-EB
5 Key Input eDLT Glass Fascia Horizon Black		5085EDLB-HB
5 Key Input eDLT Glass Fascia Ocean Mist		5085EDLB-OM
5 Key Input eDLT Glass Fascia Pure White		5085EDLB-PW
5 Key Input eDLT Glass Fascia Stainless Steel		5085EDLB-SS
5 Key Input eDLT Glass Fascia Ocean Mist - White Base		5085EDLW-OM
5 Key Input eDLT Glass Fascia Pure White - White Base		5085EDLW-PW
5 Key Input eDLT ZEN Black		R5045EDLB-ZB
5 Key Input eDLT ZEN White		R5045EDLW-ZW
Saturn Switches		
2 Key Input Glass Fascia (Available in White, Black, Stainless Steel, and Pure White)		5082NL
4 Key Input Glass Fascia (Available in White, Black, Stainless Steel, and Pure White)		5084NL
6 Key Input Glass Fascia (Available in White, Black, Stainless Steel, and Pure White)		5086NL
Saturn ZEN Switches		
C-Bus Saturn ZEN Wall Switch - 1 button		R5041NL *
C-Bus Saturn ZEN Wall Switch - 2 button		R5042NL
C-Bus Saturn ZEN Wall Switch - 3 button		R5043NL *
C-Bus Saturn ZEN Wall Switch - 4 button		R5044NL *
Cbus Wall Switch Mechanisms		
30 Series Master Mech		5031NMML
30 Series Slave Mech		5031NMS
40 SERIES MASTER MODULE (Iconic)		5041NMML
40 SERIES SLAVE MODULE (Iconic)		5041NMS
Touch Screens		
B&W Touch Screen MKII with Logic Engine		5080CTL2
B&W Touch Screen MKII with Logic Engine Stainless Steel		BS5000CTL2
B&W Touch Screen MKII with Logic Engine White		SC5000CTL2-WE
Ethernet Touch Panel, 10in, White Fascia		5000ETP10W

Note: Some products are restricted for purchase by Schneider Electric trained partners only.

* Available in Zen White and Zen Black

C-Bus System Units

The C-Bus Automation Controller is an advanced controller specifically designed to unite the C-Bus automation solution with common communication protocols. Lighting, climate control, security, entertainment and energy metering can be seamlessly and efficiently integrated.

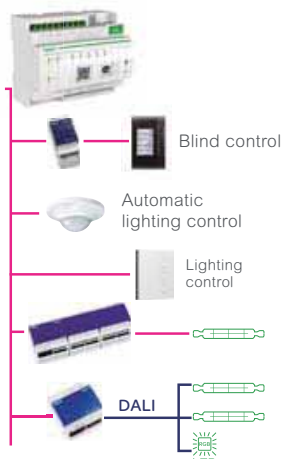

5500SHAC

Description	Ctn Qty	Item / Cat Number
PC Interface		
PC Interface	1	5500PC
PC Interface with USB Port		5500PCU
Automation Controller		
Pascal Automation Controller		5500PACA
Network Automation Controller Commercial		5500NAC
Network Automation Controller Residential		5500SHAC
Power Supplies		
Power Supply		5500PS
NAC/SHAC P/Supply		ABL8MEM24003
Network Interface		
Ethernet Network Interface		5500CN2
DMX Gateway		5500DMX
Network Bridge		5500NB
Wiser Gateway V2		5200WHC2



57540DPE



5753L

C-Bus Sensors and Thermostats

Description	Ctn Qty	Item / Cat Number
Occupance Controller		
C-BUS MULTI-SENSOR 360 DEGREE		5753PEIRL
OCC, LL SENSOR SURFACE MNT 360		57540DPE
OCC, LL, IR SENSOR S/MOUNT 360		57540DPEIR
LIGHT LEVEL SENSOR S/MOUNT 360		5754PE
Sensors		
Outdoor IP66 PIR Sensor 110°		5750WPL-GY
Indoor PIR Sensor 90°		5751L-WE
Indoor PIR Sensor 360°		5753L
Indoor Multi Sensor 360°		5753PEIRL
Outdoor IP66 Light Level Sensor		5031PEWP-GY
C-Bus remote Temp Sensor		5031RDTSL-WE
Thermostats		
C-Bus Digital Temperature Sensor Input Unit, 4 Channel		5104DTSI
C-Bus Temperature Sensor, Flat Probe		5100DTSF
C-Bus Temperature Sensor, Point Probe		5100DTSP
C-Bus Temperature Sensor, Tube Probe		5100DTST

Note: Some products are restricted for purchase by Schneider Electric trained partners only.

C-Bus Output Units

Description	Ctn Qty	Item / Cat Number
Din Rail Dimmer Range		
4 Channel Dimmer 2 Amp with Power Supply		L5504D2A
4 Channel Dimmer 2 Amp		L5504D2AP
8 Channel Dimmer 1 Amp with Power Supply		L5508D1A
8 Channel Dimmer 1 Amp		L5508D1AP
Universal Dimmer 2.5 Amp with Power Supply		L5504D2U
Universal Dimmer 2.5 Amp		L5504D2UP
Din Rail Relay Range		
4 Channel Relay 10 Amp with Power Supply		L5504RVF
4 Channel Relay 10 Amp		L5504RVFP
4 Channel Changeover Relay 10Amp/5Amp with Power Supply		L5504RVFC
4 Channel Changeover Relay 10Amp/5Amp		L5504RVFCP
4 Channel Relay 20 Amp with Power Supply		L5504RVF20
4 Channel Relay 20 Amp		L5504RVF20P
8 Channel Relay 10 Amp with Power Supply		L5508RVF
8 Channel Relay 10 Amp		L5508RVFP
12 Channel Relay 10 Amp with Power Supply		L5512RVF
12 Channel Relay 10 Amp		L5512RVFP
1 Channel Shutter Relay		L5501RBCP
1 Channel Fan Relay		L5501RFCP
Fan Relay Enclosure		5501FRE
Standard Relay Range		
2 Channel Relay 10 Amp		5102RVF
8 Channel Relay Extra Low Voltage		L5108RELVF
DSI Dimmer Range		
8 Channel DSI Gateway with Power Supply		L5508DSI
8 Channel DSI Gateway		L5508DSIP
Misc		
4 Channel Analogue Output		L5504AMP



L5504D2U



L5512RVF



L5504AMP

Note: Some products are restricted for purchase by Schneider Electric trained partners only.

DALI Control



DCDALCIP250-2



DCDALMS360



DCDAL31M2PB



DCDAL31MOD



DCDAL31MPE

Description	Ctn Qty	Item / Cat Number
DALI Native & DALI Simple		
DALI Dual Power Supply		
Dual power supply and SI interface		DCDALCIP250-2
Sensors		
DALI multi sensor - ceiling mount		DCDALMS360
DALI 30 series mech occupancy detector - master		DCDAL31MOD
DALI 30 Series Mechs		
DALI master mech - draws 8.2Amp - supports slaves		DCDAL31M2PB
DALI master mech - occupancy detector		DCDAL31MOD
DALI master mech - pe sensor		DCDAL31MPE
DALI slave mech - push button		DCDAL31SPB
DALI slave mech - push button up / down		DCDAL31SPBUD
DALI slave mech - push button rocker up / down		DCDAL31SROKUD
DALI slave mech - rotary dimmer		DCDAL31SROT

Enhance the experience

To upgrade your preprogrammed pack to a Complete Smart Home solution talk to one of our Schneider Electric Approved Installers.

An Approved Installer is someone who has been trained and approved by Schneider Electric as a specialist in using C-Bus and Dali Controls in any building. From system design, through to installation, then on to programming and commissioning, an Approved Installer will ensure that Wiser Home Control and/or Commercial Installations reach their full potential, delivering the best performance, functionality and most of all, value for money.

Schneider Electric is so confident in the work carried out by our Approved Installers, we will double our manufacturer's warranty on any project that has been inspected and endorsed as an "Approved Site".

Schneider Electric promotes the use of an Approved Installer to builders, commercial specifiers and homeowners; making them aware of the many reasons they should insist on an Approved Installer.

As part of the Approved Installer network you will have the training and accreditation to deliver the best result. For more information on becoming part of the Approved Installer network please contact your local Schneider Electric Representative.

EcoXperts

EcoExperts must be skilled in areas such as TCP/IP, lighting control design, building management systems, lighting principles, as well as sound understandings of Building Codes in New Zealand. They must also have the necessary resources to finance large scale projects, work within strict time frames, as well as managing OH&S guidelines and work practices. In addition Premium Partners must be capable of delivering professional detailed documentation and specifications for projects and tenders.

From design, documentation, installation and programming, through to commissioning after sales service, Premium Partners will assist the client in achieving their specific goals and requirements by working closely with them through the entire process to understand their specific needs and deliver a turn-key solution.

To find your local Approved Installer or Premium Partner, please visit se.com/nz (Support, Where to buy) or contact your local sales representative.

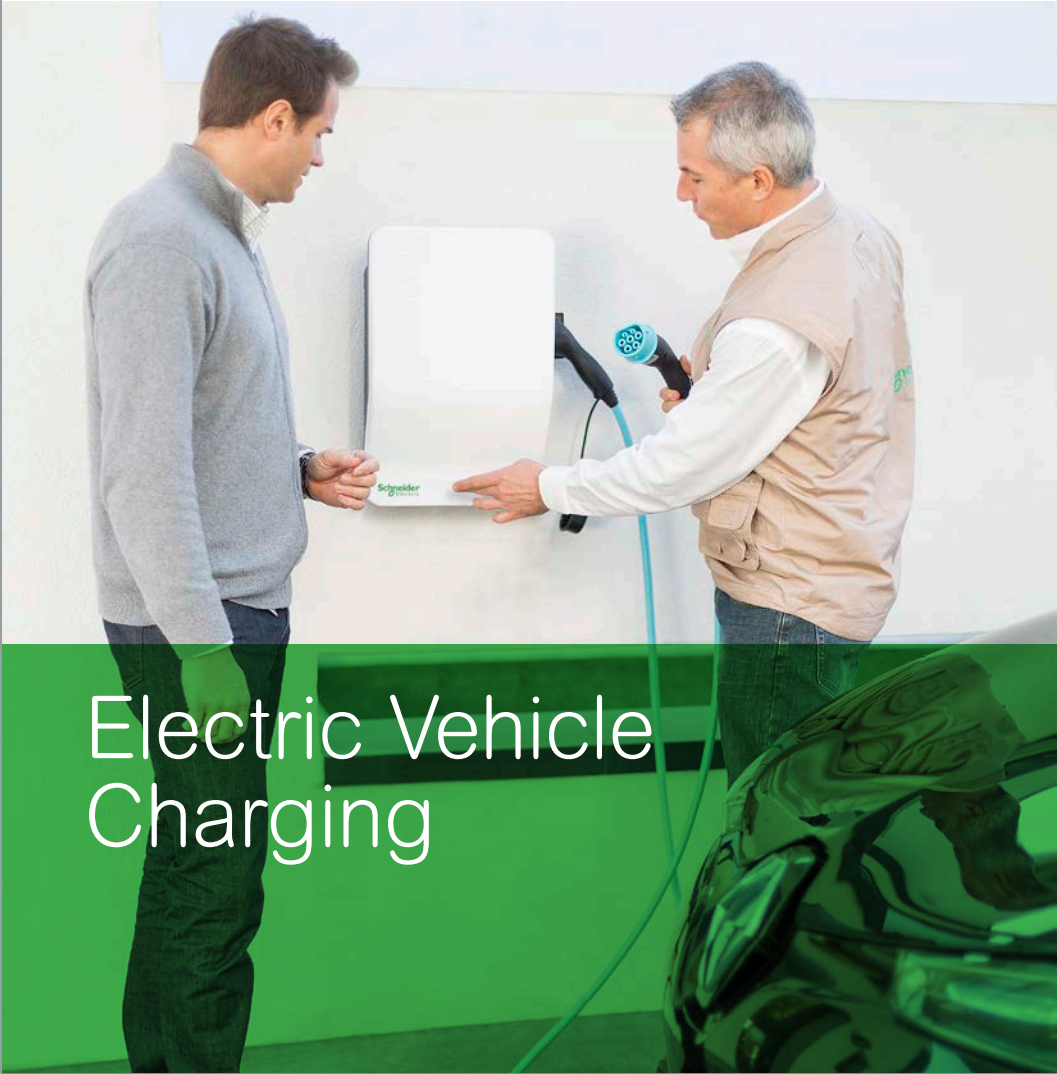

Electric Vehicle Charging

EVlink Wallbox



Electric vehicle charging for homes

The EVlink Wallbox was designed for homes or private properties, such as apartments, corporate car parks and hotels.

- Due to its robust and weatherproof design, it can be installed indoors or outdoors
- Simply connect the vehicle to the charging station: charging can start without specific action
- Charging can be stopped and then restarted using the Stop/Start button
- The charging power can be limited by any energy management device providing that this device is able to close a potential-free contact wired to the Wallbox
- Has a key lock as standard for access control
- Available in 1-phase at 7.4 kW and 3-phase at 11 and 22 kW



EVlink Wallbox

Description	Ctn Qty	Item / Cat Number
EVlink wallbox with attached 4m cable (right side)		
7.4 kW, 1-phase, with 4m cable & type 1 connector	1	EVH2S7P0AK
7.4 kW, 1-phase, with 4m cable & type 2 connector	1	EVH2S7P0CK
11 kW, 3-phase, with 4m cable & type 2 connector	1	EVH2S11P0CK
22.1 kW, 3-phase, with 4m cable & type 2 connector	1	EVH2S22P0CK
EVlink wallbox - no cable, socket for cable on right side (cable sold as separate item)		
7.4 kW, 1-phase, with type 2 socket	1	EVH2S7P04K
11 kW, 3-phase, with type 2 socket	1	EVH2S11P04K
22.1kW, 3-phase, with type 2 socket	1	EVH2S22P04K



EV B type Earth Leakage Protection

Choosing the correct RCD type for the application is critical

Electric vehicles are becoming increasingly popular, and charging stations need the appropriate protection for all users. Especially given that these stations are often located outside where they are exposed to the rain and operated daily by untrained users.

For Electric Vehicle Charging Type B Earth Leakage Protection is what you need to provide Safe and Efficient People Protection.

RCCB for EV

Description	Ctn Qty	Item / Cat Number
16A 2 poles 30mA	1	A9Z51216
25A 2 poles 30mA	1	A9Z51225
40A 2 poles 30mA	1	A9Z51240
40A 4 poles 30mA	1	A9Z51440
63A 4 poles 30mA	1	A9Z51463



A9Z51216



MODEL ILD

Protection device kits

Description	Ctn Qty	Item / Cat Number
Protection devices kit for 7.4 kW EVlink Wallbox and Smart Wallbox	1	KITWALLBOX7
Protection devices kit for 11/22.1 kW EVlink Wallbox and Smart Wallbox	1	KITWALLBOX22

Note: Depending on the reference, each kit would have an MCB and RCD (or RCBO), and under-voltage release

Notes



Industrial Electrical Accessories



56 Series™

Powered by Innovation

Providing superior user and installer solutions, the iconic 56 Series™ is taken to a new level. New range, new benefits, New Zealand tough.

Since the beginning of the 1980s the 56 Series™ has earned a reputation for top performance in resistance to the harsh treatment of industrial environments.

Introducing the NEW 56 Series™, a range with easier operation, improved strength and integrity, whilst maintaining the 56 Series™ heritage look, and being fully backwards compatible with the old range.

Design Innovation:

Several improvements have been made on the existing range through listening to our customers and making their requests a reality.

- Easier switch and socket operation
- Modern contoured profile
- 56 Series™ heritage look and fully backwards compatible
- Reduction of potential dirt build-up areas
- Improved strength and reliability



Patented gasket system

- Two grades of plastic using an over-moulded process
- IP66 without the use of No. 9 caps
- More rigidity
- Increased integrity of cover to enclosure seal



Laser engraved ratings

- The message is permanent and one of quality
- No more silver ratings labels that can fade or fall off
- Switch OFF/ON indicators raised and printed



Socket success

- Easier operation and opens further
- Strengthened hinge flap
- Co-injected flap gasket seal, improves sealing integrity
- More space to access plugs

56 Series™

Get the Facts

This new release takes the range to a new level, but the fundamental benefits that make 56 Series™ what it is today remain:

- Proven IP66 Protection
 - Laboratory tested and field proven
- Superior Impact Strength
 - Hi-impact polycarbonate materials used in 56 Series™ are proven and tested to operate in extreme temperatures from -40° to +55°C*
- High Level of Switch Performance
 - Rated up with the best in the business with most switches being motor rated with AC23A and AC3 to IEC60947-3
- Specially Formulated Chemical Resistance
 - In the conditions this range is required to operate, one plastic will not do for all. Resistant Orange and White have been developed for environments where harsh chemicals are used
- Solvent Bonding Capability
 - 56 Series™ PVC enclosures are able to be solvent bonded to standard PVC conduit fittings using recommended sealants.
- Greater UV Resistance
 - 56 Series™ materials are engineered and proven to provide a higher degree of protection than comparable products

- Full Range of Matching Gear
 - The most comprehensive range available catering for the complete solution, allowing the job to be done properly
- Modules Making Assembly Simple
 - From a single switch or socket, up to a full 16 gang station, the 100x100mm module design allows customer builds and modification to suit a massive range of requirements
- Quick, Easy, and Safe Wiring
 - Designed and engineered with the installer in mind, the 56 Series™ offers many simple and innovative features to assist

* Some products with electronic components do not reach these extremes, these will be listed with the accompanying installation guidelines



56 Series™

With features designed to outperform all other protected series

Features and benefits with the NEW range...

Fundamental to the range from 1981 to now...

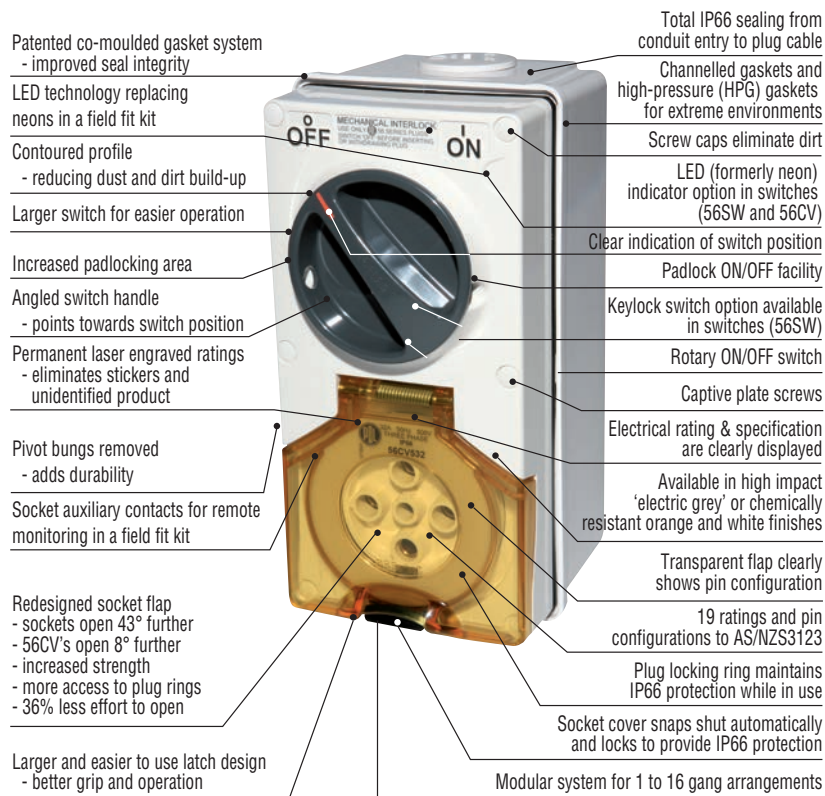

PDL 56 Series – make the right choice

For optimum performance it's important to match your Industrial Switchgear's design and construction to your specific industry.



Neutral

Grey (GY)

General industrial use, chemically neutral, dusty or clean, wet or dry, indoors or out (UV resistant)

Ideal for use in:

- > Plant rooms
- > Warehouses/Distribution centres
- > Workshops
- > Assembly plants
- > Shopping centres
- > Tool rooms
- > Swimming centres
- > Material handling & transport



Alkaline

Chemical Resistant Grey (CG)

Resistant to caustic wash-down / alkali-based chemicals, dusty or clean, wet or dry, indoors only (not UV resistant)

Ideal for use in:

- > Caustic wash-down areas in food processing
- > Boning rooms
- > Abattoirs
- > Dairy processing plants
- > Seafood processing
- > Kitchens/production lines using commercial or industrial deep fryers



Acid

Chemical Resistant Orange (RO)

Chemical Resistant White (RW)

Resistant to acid base chemicals, dusty or clean, wet or dry, indoors or out (UV resistant)

Ideal for use in:

- > Citrus plants
- > Waste water treatment
- > Electroplating
- > Coal wash-down plants
- > Food preparation with acid based cleaners
- > Wineries
- > Breweries



Heavy Duty

Heavy Metal – WilcoROWCO

Heavy industrial applications, chemically neutral, dusty or clean, wet or dry, Indoors or outdoors, heavy impact areas, vandal prone areas

Ideal for use in:

- > Foundry, furnaces
- > Power generation & distribution
- > Cement plants
- > Quarries, open cut mines
- > Heavy transport
- > Welding outlets
- > Public areas

Chemical Resistance Guide					
Chemical type	All Mounting Enclosures	Grey (GY) Transparent Covers	Resistant Orange (RO) Resistant White (RW) Covers	Chemical Grey (CG) Covers	Plugs
Acids					
Hydrochloric 10%	R	R	R	R	R
Nitric 10%	R	LR	R	R	LR
Acetic acid 10%	R	R	R	LR	LR
Sulphuric 100%	R	LR	R	LR	LR
Alkalis					
Sodium hydroxide 10% (Caustic soda)	R	NR	LR	R	LR
Potassium hydroxide 100%	LR	NR	NR	R	LR
Sanitising solutions					
Chlorinated alkaline foaming cleaner 10%	R	NR	NR	R	LR
Ammonium sanitiser	R	NR	NR	R	LR
Vegetable oils					
Olive oil	R	NR	NR	R	LR
Canola oil	R	NR	NR	R	LR
Solvents					
Methane	LR	R	R	-	R
Propane	R	R	R	-	R
Ethylene glycol	R	R	R	-	R
Glycerol (Glycerine)	R	LR	LR	R	R
Methyl alcohol (Methanol)	R	R	R	LR	R
Ethyl alcohol (Ethanol)	R	R	R	NR	R
Aniline	NR	NR	NR	NR	LR
Methyl benzene	NR	NR	LR	NR	LR
Xylene	NR	NR	LR	NR	LR
Dimethyl ethyl	R	R	R	-	R
Acetone	R	LR	LR	LR	LR
Acetophenone	NR	NR	LR	NR	LR
Ethyl methyl ketone	NR	NR	LR	NR	R
Isopropyl Alcohol	-	R	R	NR	R





























Chemical Resistance Guide					
Chemical type	All Mounting Enclosures	Gray (GY) Transparent Covers	Resistant Orange (RO) Resistant White (RW) Covers	Chemical Grey (CG) Covers	Plugs
Automotive					
Unleaded Petroleum	R	NR	NR	R	LR
Diesel	-	R	R	NR	LR
Brake Fluid	-	NR	NR	NR	LR
Grease at 60 °C (Rocol 12475)	-	LR	LR	-	-
Grease at 60°C (Rocol Sapphire Hi Temp)	-	LR	LR	-	-
Lubricating oil (10w/40)	-	-	-	-	R
Hydraulic oil (HF-105L)	-	-	-	-	R
Oxidising agents					
Sodium hypochlorite 5%	R	R	R	R	LR
Hydrogen peroxide 30%	R	R	R	R	LR
Water					
Ambient	R	R	R	R	R
Hot > 60 °C	R	R	R	R	LR
Miscellaneous					
Detergent @ 50 °C	R	LR	NR	R	LR
Magnesium sulphate	R	R	R	-	R
Salts					
Calcium Chloride 10%	R	R	R	R	LR
Sodium Chloride 5%	R	R	R	R	R
Ammonium Hydroxide 100%	R	R	R	R	R

This table should be used as a guide only. The end user should evaluate the suitability of any chemical with any plastic.

Resistant **R** Limited Resistance **LR** Not Resistant **NR**

When products are required to use in environments with high concentrations of acids, bases, or oils, it is recommended to contact your local Schneider Electric office for support.

56 Series™ Product Master

Description	Configuration Female (S0, CV, CR, CSC, SPO)	Ref	Socket Outlet 56S0	Combination Socket Outlet 56CV
Ordering Info			GY, RO, RW	GY, RO, RW
250V				
3 pin (flat) 10A Aust/NZ		A	56S0310 56S0310A	56CV310, 56C310RCD30 56C310EL2P, 56S04ELP15
3 pin (2 flat & round earth) 10A Aust/NZ		B	56S0310R	
3 pin (flat) 15A Aust/NZ		D	56S0315 56S0315A	56CV315
3 pin (flat) 20A Aust/NZ		E	56S0320F	
3 pin (round) 20A		F	56S0320	56CV320 56C320RCD30
3 pin (round) 32A		G	56S0332	56CV332
500V				
4 pin (round) 16A		H	56S0416	56CV416
4 pin (round) 16A high cycle ³		I	56S0416K	
4 pin (round) 20A		J	56S0420	56CV420
4 pin (round) 32A		K	56S0432	56CV432
4 pin (round) 40A		L	56S0440	56CV440
4 pin (round) 50A		M	56S0450	56CV450
5 pin (round) 16A		N	56S0516	56CV516
5 pin (round) 20A		O	56S0520	56CV520
5 pin (round) 32A		P	56S0532	56CV532
5 pin (round) 40A		Q	56S0540	56CV540
5 pin (round) 50A		R	56S0550	56CV550
6 pin (round) 16A		S	56S0616	56CV616
7 pin (round) 16A		T	56S0716	56CV716
7 pin (round) 20A		U	56S0720	56CV720
CEE17²				
110V				
3 pin (round) 16A		V	56S0316/110	
250V				
3 pin (round) 16A		W	56S0316/240, 56S0316CEE	56CV316/240 56C316RCD30
3 pin (round) 32A		X	56S0332CEE	
400V				
4 pin (round) 16A		Y	56S0416CEE	
4 pin (round) 32A		Z	56S0432CEE	
4 pin (round) 32A container ⁴		Aa	56S0432CEE	
5 pin (round) 16A		Bb	56S0516CEE	
5 pin (round) 32A		Cc	56S0532CEE	

Notes:

- 1) 56AI310 suits 56CSC310 only; 56AI315 suits 56CSC315 only.
- 2) 56SPO310 and 56SPO315 RO and RW only.
- 3) All CEE17 sockets are available in grey only.

56 Series™ Product Master

Connector 56CR or 56CSC or 56SPO	Configuration Male (P, PA, AI)	Ref	Plug 56P or 56PA	Appliance Inlet 56AI
Orange/Clear as standard. For RO add V to the stock code (i.e. 56CRV310), except CSC & SPO add RO			Orange/Clear as standard. For RO add V to the stock code (i.e. 56PV310 or 56PAV320). Not available in RW	GY only except 3 pin 10A & 15A available in RO or RW on request
56CR310, 56CSC310 56SPO310 ²		A	56P310	56AI310 ¹
		B	56P310R	
56CR315, 56CSC315 56SPO315 ²		D	56P315	56AI315 ¹
		E	56P320F	
MACTRO™ 56CR320		f	MACTRO™ 56P320, 56PA320, 56P320QC, 56PA320QC,	56AI320
56CR332		g	56P332 56PA332	56AI332
MACTRO™ 56CR416		h	MACTRO™ 56P416, 56PA416, 56P416QC, 56PA416QC,	56AI416
		i	MACTRO™ 56P416K 56PA416K	
MACTRO™ 56CR420		j	MACTRO™ 56P420, 56PA420, 56P420QC, 56PA420QC	56AI420
56CR432		k	56P432, 56PA432	56AI432
56CR440		l	56P440 56PA440	56AI440
56CR450		m	56P450 56PA450	56AI450
MACTRO™ 56CR516		n	MACTRO™ 56P516, 56PA516, 56P516QC, 56PA516QC	56AI516
MACTRO™ 56CR520		o	MACTRO™ 56P520, 56PA520, 56P520QC, 56PA520QC	56AI520
56CR532		p	56P532 56PA532	56AI532
56CR540		q	56P540 56PA540	56AI540
56CR550		r	56P550 56PA550	56AI550
		s	MACTRO™ 56P616, 56PA616	
		t	MACTRO™ 56P716, 56PA716	
		u	MACTRO™ 56P720, 56PA720	
BALS311 BALS31240		W	BALS211 BALS21238	BALS2638
BALS31244		X	BALS21240	
		Y	BALS21349	
		Z	BALS21351	
BALS31423		Aa	BALS21485	
		Bb	BALS21239	
		Cc	BALS21241	

- 4) 56SO432CCEE and matching plug and connector specifically for international container equipment – earth pin position = 3H.
- 5) 56SO416K and matching plugs with a special keyway for high cycle applications where standard products should not be used.

56 Series™

Note: Most products are available in chemical resistant versions. Check for availability.



56P450



56P310



56PA520

Description	Ctn Qty	Item / Cat Number	Ctn Qty	Item / Cat Number
-------------	---------	-------------------	---------	-------------------

Plugs

Available Orange/Clear as standard.

For Chemical Resistant Orange specify "V" in the part number i.e.: 56PAV320.

Plugs, 250V Single Phase ^

3 pin 10A	4	56P310		
3 pin 10A RE	4	56P310R		
3 pin 15A	4	56P315		
3 pin 20A flat	4	56P320F		
		STRAIGHT		ANGLED
3 pin 20A MACTRO™	4	56P320	4	56PA320
3 pin 32A MACTRO™	4	56P332	4	56PA332

Plugs, 500V 3 Phase ^

4 pin 16A MACTRO™	4	56P416	4	56PA416
4 pin 16A MACTRO™	4	56P416K *	4	56PA416K *
4 pin 20A MACTRO™	4	56P420	4	56PA420
4 pin 32A MACTRO™	4	56P432	4	56PA432
4 pin 40A MACTRO™	4	56P440	4	56PA440
4 pin 50A MACTRO™	4	56P450	4	56PA450
5 pin 16A MACTRO™	4	56P516	4	56PA516
5 pin 20A MACTRO™	4	56P520	4	56PA520
5 pin 32A MACTRO™	4	56P532	4	56PA532
5 pin 40A MACTRO™	4	56P540	4	56PA540
5 pin 50A MACTRO™	4	56P550	4	56PA550
6 pin 16A MACTRO™	4	56P616	4	56PA616
7 pin 16A MACTRO™	4	56P716	4	56PA716
7 pin 20A MACTRO™	4	56P720	4	56PA720

* K: Dedicated keyway configuration

^ For pin configurations refer to 56 Series™ Product Master – pgs 169-170. Refer page 172 for MACTRO™ 'How to' Guide.

The MACTRO™ 'How To' Guide:

1: Open it



Unlocked

Place 56MACTRO unlocking tool into spring clip, **rotate** lock-nut to **unlocked**. Alternatively, insert screwdriver and **press** spring clip, then **rotate** lock-nut to **unlocked**.

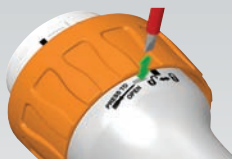

Press clip once & **remove** screwdriver.



Twist plug body left to open.

No need to fully remove the cable nut, it can stay on!

2: Wire it

1. Thread cable through MACTRO™ cable nut and strip as shown.
2. For screw terminals, twist the conductors.
3. Terminate the conductors to the appropriate terminals in the pin housing.
4. Double check the wires are fitted to the correct terminals and the terminals are secured tight.

3: Close it



Align arrows, twist body right and **click** to close.

LOCK IT!



Locked

Tighten the cable gland until fully done up, then rotate the lock nut to **locked**.

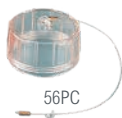

56PC



56POK



56AM25



56SHM



56S0310



56S0332LEGY

56 Series™

Description	Ctn Qty	Item / Cat Number
Plug Accessories and Parts*		
Plug cover, suits 16A to 50A	10	56PC
Suspension hook, small, suits 10A, 15A	20	56POK
Suspension hook MACTRO™, medium, suits 16A, 20A	50	56SHM
Suspension hook MACTRO™, large, suits 32A - 50A	15	56SHL
Conduit nut adaptor M25 thread MACTRO™, suits 16A, 20A	100	56AM25
Cable gland unlock tool	100	56MACTRO

Sockets

Available in Grey (GY), Resistant Orange (RO), and Resistant White (RW).
NOTE: All product supplied less enclosure.

Socket Outlets, 250V Single Phase

3 pin 10A	4	56S0310
3 pin 10A round earth	4	56S0310R
3 pin 10A auto switch	4	56S0310A
3 pin 10A double socket	4	56S0310/2
3 pin 15A	4	56S0315
3 pin 15A auto switch	4	56S0315A
3 pin 20A	4	56S0320
3 pin 20A flat pins	4	56S0320F
3 pin 32A	4	56S0332

* Plug covers also suit appliance inlets (56AI).
RO and RW priced 5% more than standard GY.
CG "Chemical Grey" priced 15% more than standard GY
(not all cat no. are available in Chemical Grey)

56 Series™

Description	Ctn Qty	Item / Cat Number
Socket Outlets, 500V 3-Phase		
4 pin 16A	4	56SO416
4 pin 16A	4	56SO416K *
4 pin 20A	4	56SO420
4 pin 32A	4	56SO432
4 pin 40A	4	56SO440
4 pin 50A	4	56SO450
5 pin 16A	4	56SO516
5 pin 20A	4	56SO520
5 pin 32A	4	56SO532
5 pin 40A	4	56SO540
5 pin 50A	4	56SO550
6 pin 16A	4	56SO616
7 pin 16A	4	56SO716
7 pin 20A	4	56SO720
Socket Outlet Configurations to IEC 60309-1		
<i>Outdoor applications – caravan/marinal/camping grounds/building sites.</i>		
240V, single phase, IP66: 3 pin 16A	4	56SO316240 ^
110V, single phase, IP66: 3 pin 16A	4	56SO316110
Socket Accessories		
Socket cover only, available GY, RO and RW	4	56SOCOVER



56SO420



56SO532LEGY



56SO720LEGY



56SO316/240

* K: Dedicated keyway configuration.
 ^ Compatible with Bals 211 and Bals 21238 plugs.
 For pin configurations refer to 56 Series™ Product Master – pgs 169-170.
 RO and RW priced 5% more than standard GY.
 CG "Chemical Grey" priced 15% more than standard GY
 (not all cat no. are available in Chemical Grey).



56SW110



56SW220LEGY



56PB2G/R

56 Series™

Description	Ctn Qty	Item / Cat Number
-------------	---------	-------------------

Switches

Available in Grey (GY), Resistant Orange (RO), and Resistant White (RW).
NOTE: All product supplied less enclosure. Neon switches replaced by field fit LED indicator kits.

Switches, 240V Single Phase*

10A S.P.	4	56SW110
10A 2 way	4	56SW1102
10A S.P./Interm.	4	56SW1102I
AC21A ratings listed below. Switches also rated for AC23A and AC3 loads (derating required).		
16A S.P.	4	56SW116
20A S.P.	4	56SW120
32A S.P.	4	56SW132
50A S.P.	4	56SW150
10A D.P.	4	56SW210
16A D.P.	4	56SW216

Push Button Switches, 240V Single Phase

Push Button Switches, N/O, N/C, 16A resistive:

Red	8	56PB1RD
Green	8	56PB1GN
2 gang, Red and Green	8	56PB2

* To order a key locking version, add 'K' after 'SW' (e.g. 56SWK110).

The price of this feature is (additional to the basic item): K \$P.O.A.
RO and RW priced 5% more than standard GY.
CG "Chemical Grey" priced 15% more than standard GY
(not all cat no. are available in Chemical Grey).

56 Series™

Description	Ctn Qty	Item / Cat Number
Sunset Switch		
Sunset switch, IP66, 10AX, Dusk to Dawn or Dusk plus 2, 4, 6, 8 Hour adjustable timer with adjustable light level sensitivity.		
Sunset switch	4	56SS10
With enclosure (E1S)	4	56SS10WE
Both models include test cover.		
Switches, 415V 3 Phase*		
AC21A ratings listed below. Switches also rated for AC23A and AC3 loads (derating required).		
20A D.P.	4	56SW220
32A D.P.	4	56SW232
50A D.P.	4	56SW250
10A T.P.	4	56SW310
16A T.P.	4	56SW316
20A T.P.	4	56SW320
32A T.P.	4	56SW332
40A T.P.	4	56SW340
50A T.P.	4	56SW350
50A T.P. (2 gang)	2	56SW3502 #
63A T.P. (2 gang)	2	56SW3632 #
20A 4.P. (2 gang)	2	56SW4202KG >
32A 4.P. (2 gang)	2	56SW4322KG >



56SS10



56SW320LEGY



56SW363/2

> Not available in key lock versions.

Require 56E2 enclosure.

* To order a key locking version, add 'K' after 'SW' (e.g. 56SWK110).

The price of this feature is (additional to the basic item): K \$P.O.A.

RO and RW priced 5% more than standard GY.

CG "Chemical Grey" priced 15% more than standard GY

(not all cat no. are available in Chemical Grey).



56SWB3322KGLEGY



56SW01

56 Series™

Description	Ctn Qty	Item / Cat Number
-------------	---------	-------------------

Base Mount Switches, 415V 3 Phase

Introducing a range of 56 Series™ base mounted switch mechanisms. This range extension whilst boasting a list of new features and benefits maintains the 56 Series™ fundamentals that make 56 Series™ what it is today.

Features & Benefits

- Easier installation & maintenance resulting from the base mount switches which allow the cables to run directly into the switches.
- Clear access to terminals.
- High AC3, AC21A, AC23A and M ratings
- 20 – 63A, 3 & 4 pole options available.
- 2 Gang cover
- Same tough enclosure (enclosure sold separately)
- Retro fit multi gang enclosures
- GY, RO & RW colour and chemical resistant options (RO & RW not available in all variants)
- Compliant to all applicable AS/NZS & IEC standards

32A, T.P. (2 Gang)	1	56SWB3322KG #
40A, T.P. (2 Gang)	1	56SWB3402KG #
63A, T.P. (2 Gang)	1	56SWB3632KG #
20A, 4.P. (2 Gang)	1	56SWB4202KG #
32A, 4.P. (2 Gang)	1	56SWB4322KG #

Switch Accessories

LED indicator kits for NEW 56 Series™ switches and combination switched socket outlets. Triple LED suits 2 gang switches only

Single LED Kit, 240V/415V Red	1	56LEDK1
Triple LED Kit, 240V/415V Red, Blue, White	1	56LEDK3

Auxiliary contacts for 56SW350/2 and 56SW363/2 only

0.1A 125V gold plated	4	56SW01
15A 250V nickel silver	4	56SW15

Require 56E2 enclosure (sold separately)
Base Mount Switches not available in CG.

56 Series™

BASE MOUNT VSD ISOLATOR WITH EMC KIT

New addition, new benefits, New Zealand tough.

Introducing a range of 56 Series™ base mounted switch mechanisms. Now also catering for the VSD market offering a solution to your RFI screening requirements for VSD output motor isolation. This range extension offers the ability to add an early break auxiliary for a controlled power removal from the VSD.

Features & Benefits

- Base mount isolator makes for easier installation & maintenance
- Allows for screened VSD cables to run directly into the isolator whilst terminating cable screens and bonding them via a RFI/EMC gland plate.
- The ability to add an EB (early break) auxiliary for a controlled power removal from the VSD improves isolator life and prevents VSD from faulting when switching the field isolator.
- Clear access to terminals.
- AC23 motor rated for heavy-duty switch control
- Two x 8mm Lock OFF padlock facilities
- LED indicator switch options
- Single LED Kit "RED" Cat no. "56LEDK1"
- Triple LED kit "RED, BLUE, WHITE" Cat no. "56LEDK3"
- Same tough enclosure
- Retro fit multi gang enclosures
- GY, RO & RW colour and chemical resistant options
- Compliant to all applicable AS/NZS & IEC standards
- Meets the requirements of Standards NZ Handbook "SNZ HB 6117:2014 Electrical Installations in dairy sheds"

Best Practice (Screened motor cable)

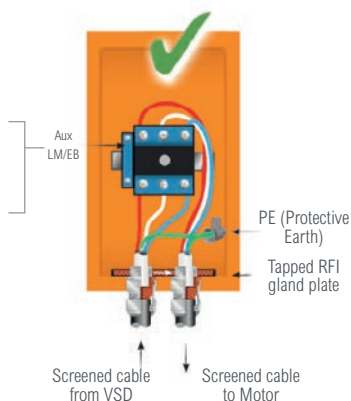

The Range

56 Series™ CATALOGUE No.	IEC60947-3 AC-23A Rating	3 Poles	-GY	-RO	-RW	Max cable size mm ²	Auxiliary – early break (K&N Part no.) (sold separately)
56SWB3322KG	11kW	✓	✓	✓	✓	6	K0-H010/C11-VE
56SWB3402KG	15kW	✓	✓			16	K1-H010/C11-VE
56SWB3632KG	22kW	✓	✓	✓		16	K1-H010/C11-VE

Note: For RFI gland plate to suit PDL56E2/25/25 enclosure (2x25mm Gland entry's) - order K&N Part no. 9RFIPDL56 (sold separately)

- Enclosure sold separately

- Use Screen Motor Cables, ensuring that the screen is bonded around the full 360 degrees of its surface by the use of an EMC screen gland.



56SW120COLEGY



56SW320FRLEGY



56 Series™

Description	Ctn Qty	Item / Cat Number
Switches, 500V 3 Phase^{>}		
AC21A ratings listed below. Switches also rated for AC23A and AC3 loads (derating required).		
20A T.P.	4	56SW320KG
20A T.P. LM/EB AUX	4	56SW320KGAX
32A T.P.	4	56SW332KG
32A T.P. LM/EB AUX	4	56SW332KGAX
40A T.P.	4	56SW340KG #
63A T.P.	4	56SW363KG #
20A 4.P.	4	56SW420KG [^]
32A 4.P.	4	56SW432KG [^]
20A 6.P.	4	56SW620KG [^]
Forward/Reverse and Changeover Switches[^]		
S.P. 20A changeover	4	56SW120CO [^]
AC21A 20A		
AC23A 2.5kW (3.3hp) 15A		
AC3 2.2kW (3.0hp)		
T.P. 20A changeover	4	56SW320CO [^]
AC21A 20A		
AC23A 380 - 500V 7.5kW (10hp) 15A		
220 - 240V 2.5kW (3.3hp) 15A		
AC3 380 - 500V 5.5kW (7.5hp)		
220 - 240V 2.2kW (3.0hp)		
T.P. 32A changeover	4	56SW332CO [^]
AC21A 32A		
AC23A 380 - 500V 15kW (15hp) 21A		
220 - 240V 7.5kW (4hp) 21A		
AC3 380 - 500V 11kW (10hp)		
220 - 240V 5.5kW (4hp)		
S.P. or T.P. 20A forward/reverse	4	56SW320FR [^]
AC21A 20A		
AC23A 380 - 500V 7.5kW (10hp) 15A		
220 - 240V 2.5kW (3.3hp) 15A		
AC3 380 - 500V 5.5kW (7.5hp)		
220 - 240V 2.2kW (3.0hp)		

[^] K versions not available and not suited for LED kits.

[>] K versions not available.

2 or 3 gang enclosure may be needed for adequate wiring space.

RO and RW priced 5% more than standard GY.

CG "Chemical Grey" priced 15% more than standard GY (not all cat no. are available in Chemical Grey).

56 Series™

Description	Ctn Qty	Item / Cat Number
Combination Switched Sockets		

*Available in Grey (GY), Resistant Orange (RO), and Resistant White (RW).
NOTE: All product supplied less enclosure.*

250V Single Phase* (Interlock on 32A)

AC21A ratings listed below. Switches also rated for AC23A and AC3 loads (derating required).

3 pin 10A	2	56CV310
3 pin 15A	2	56CV315
3 pin 20A	2	56CV320
3 pin 32A	2	56CV332

500V 3 Phase* (Interlock on 32A and above)

AC21A ratings listed below. Switches also rated for AC23A and AC3 loads (derating required).

4 pin 16A	2	56CV416
4 pin 20A	2	56CV420
4 pin 32A	2	56CV432
4 pin 40A	2	56CV440
4 pin 50A	2	56CV450
5 pin 16A	2	56CV516
5 pin 20A	2	56CV520
5 pin 32A	2	56CV532
5 pin 40A	2	56CV540
5 pin 50A	2	56CV550
7 pin 16A	2	56CV716
7 pin 20A	2	56CV720



56CV310



56CV416



56CV720LEGY

* Keylock options not available.

For pin configurations refer to 56 Series™ Product Master – pgs 169-170.
RO and RW priced 5% more than standard GY.
CG "Chemical Grey" priced 15% more than standard GY
(not all cat no. are available in Chemical Grey).



56RCD20-30



56C310RCD30



56TC7D



56TCU



56PBT10

56 Series™

Description	Ctn Qty	Item / Cat Number
-------------	---------	-------------------

Combination Switched Sockets to IEC60309-1, IP66

Also complies with IEC 309 and CEE 17. Supplied as Switch/Socket (CV).

240V:	3 pin 16A	2	56CV316240 ^
-------	-----------	---	--------------

Combination Switched Socket Accessories

Single LED Kit, 240V/415V Red	1	56LEDK1
-------------------------------	---	---------

Earth Leakage Protection, 250V Single Phase

Available in Grey (GY), Resistant Orange (RO), and Resistant White (RW).

Earth leakage only:

20A RCD, 30mA	4	56RCD2030
---------------	---	-----------

Earth leakage only with socket outlet:

3 pin 10A	2	56C310RCD30
-----------	---	-------------

3 pin 16A	2	56C316RCD30 ^
-----------	---	---------------

3 pin 20A	2	56C320RCD30
-----------	---	-------------

Time Switches

16A resistive, 7 day timers:

Mechanical synchronous 1 channel, 2hr switching min 150hr backup	4	56TC7DB
---	---	---------

24 hour timers:

Mechanical synchronous 1 channel, 15min switching min 150hr backup	4	56TC24HB
---	---	----------

Universal timer – Digital quartz, 10Yr Bat. backup, 1 Channel, 20 storage spaces	4	56TCU
---	---	-------

Push Button BLE Time Delay Switch - 10AX, 15A, 240V	4	56PBT10
---	---	---------

RO and RW priced 5% more than standard GY.
CG "Chemical Grey" priced 15% more than standard GY
(not all cat no. are available in Chemical Grey).

56 Series™

Description	Ctn Qty	Item / Cat Number
Appliance Inlets		
<i>Available in Grey (GY) only, except 3 pin 10A and 15A also RO and RW. NOTE: All product supplied less enclosure.</i>		
Appliance Inlets, 250V Single Phase		
3 pin 10A (one gang)	4	56AI310
3 pin 15A (one gang)	4	56AI315
3 pin (round) 20A (2 gang)	2	56AI320 *
3 pin (round) 32A (2 gang)	2	56AI332



56AI310

* Grey available only.
RO and RW priced 5% more than standard GY.
CG "Chemical Grey" priced 15% more than standard GY
(not all cat no. are available in Chemical Grey).



56AI532



56CS310



56CR332

56 Series™

Description	Ctn Qty	Item / Cat Number
-------------	---------	-------------------

Appliance Inlets, 500V 3 Phase

NOTE: For replacement clear cap order 56PC – page 173

4 pin 16A	2	56AI416 *
4 pin 20A	2	56AI420 *
4 pin 32A	2	56AI432 *
4 pin 40A	2	56AI440 *
4 pin 50A	2	56AI450 *
5 pin 16A	2	56AI516 *
5 pin 20A	2	56AI520 *
5 pin 32A	2	56AI532 *
5 pin 40A	2	56AI540 *
5 pin 50A	2	56AI550 *

Cord Connectors

Available Orange/Clear as standard

For chemical Resistant Orange specify "V" in part number i.e.: 56CRV310

Cord Connectors, 250V Single Phase

3 pin 10A (fits 56AI310)	4	56CSC310 #
3 pin 15A (fits 56AI315)	4	56CSC315 #
3 pin 10A (now fits POK)	6	56CR310 #
3 pin 15A	6	56CR315 #
3 pin 20A MACTRO™	4	56CR320 #
3 pin 32A MACTRO™	4	56CR332 #

* Grey available only.

Not available in White.

For pin configurations refer to 56 Series™ Product Master – pgs 169-170.

RO and RW priced 5% more than standard GY and Orange/Clear.

2 Gang appliance inlets not available in CG.

56 Series™

Description	Ctn Qty	Item / Cat Number
Cord Connectors, 500V 3 Phase		
4 pin 16A MACTRO™	4	56CR416 #
4 pin 20A MACTRO™	4	56CR420 #
4 pin 32A MACTRO™	4	56CR432 #
4 pin 40A MACTRO™	4	56CR440 #
4 pin 50A MACTRO™	4	56CR450 #
5 pin 16A MACTRO™	4	56CR516 #
5 pin 20A MACTRO™	4	56CR520 #
5 pin 32A MACTRO™	4	56CR532 #
5 pin 40A MACTRO™	4	56CR540 #
5 pin 50A MACTRO™	4	56CR550 #

Note: Mactro™ connectors suit Cat No. 56SHM and 56SHL suspension hooks, see page J11.

Switched Pendant Outlets, 250V Single Phase

Available in Chemical Resistant Orange (RO) and White (RW).

3 pin 10A	4	56SPO310
3 pin 15A	4	56SPO315



56CR432



56CR540



56SPO310

Not available in White.
RO and RW priced 5% more than standard GY and Orange/Clear.



56E1S



56E2



56E2V



56PE2

56 Series™

Description	Ctn Qty	Item / Cat Number
-------------	---------	-------------------

Enclosures

Available in Grey (GY), Orange (RO), and White (RW)

Modular Enclosures UV Stabilised

1 gang shallow (38mm)	16	56E1S >
1 gang standard (63mm)	12	56E1 >
1 gang standard	12	56E/2020 >
1 gang standard	12	56E12525 >
2 gang shallow	8	56E2S
2 gang standard	6	56E2
2 gang deep (100mm)	1	56ED2/40
2 gang standard	6	56E2/25/25
2 gang standard	6	56E2/40
2 gang vertical	2	56E2V >
2 gang standard (2x25mm conduit entries one end only, RO only)	6	56E2FOOD
3 gang standard	3	56E3
3 gang standard	3	56E3/25/25
4 gang standard	3	56E4
4 gang vert/horz	2	56E4VH
4 gang standard (No conduit entries)	2	56E4VHUN
6 gang standard	3	56E6
8 gang standard	1	56E8
9 gang standard	1	56E9
16 gang standard	1	56E16
Enclosure bridge	20	56BRIDGE
Enclosure divider	20	56DIVIDER
Enclosure Mounting Boss	1	PDL3S130GY

Pendant Enclosures UV Stabilised >

2 gang – 25mm entry	2	56PE225 >
2 gang – 32mm entry	2	56PE232 >

* Grey available only.

> For single gang units only.

RO and RW priced 5% more than standard GY and Orange/Clear.

CG "Chemical Grey" priced 15% more than standard GY

(not all cat no. are available in Chemical Grey).

56 Series™

Description	Ctn Qty	Item / Cat Number
Enclosure Lids		
<i>Available in Grey (GY), Orange (RO), White (RW), and Clear (CL). Note: 56XDL1 not available in Orange and White.</i>		
1 gang (28mm)	8	56L1
1 gang extra deep (100mm)	4	56XDL1
2 gang	4	56L2
2 gang deep (77mm)	2	56DL2
3 gang	6	56L3
4 gang	2	56L4
4 gang deep	2	56DL4
6 gang deep	2	56DL6
DIN Mounting MCB/RCD Cover		
2 gang cover for MCB/RCDs mounting on standard 56E2 or larger enclosures inc DIN rail.		
4 pole width inc DIN rail	4	56CB4
DIN rail kit for 56CB4	1	1CB100
13 way fully equipped board, includes enclosure, DIN rail, N+E bars and links	1	56CB13 *
IP66 Module Adapter Covers		
Single aperture, 300 Series module adapter	8	56MO3001
Double aperture, 300 Series module adapter	8	56MO3002
Single aperture, 600 Series module adapter	8	56MO5001
Double aperture, 600 Series module adapter	8	56MO5002



RO and RW priced 5% more than standard GY and CL.
 * Grey available only
 CG "Chemical Grey" priced 15% more than standard GY
 (not all cat no. are available in Chemical Grey).



56FA1



56FA2



56L1/22/2



56MF



56D



56PLUG20

56 Series™

Description	Ctn Qty	Item / Cat Number
Flush Surrounds and Accessories		
1 gang (157mmx157mm)	3	56FA1
2 gang (157mmx254mm)	5	56FA2
3 gang (157mmx350mm)	1	56FA3
4 gang (254mmx254mm)	1	56FA4
<i>Available in Grey (GY), Orange (RO) and White (RW).</i>		
Enclosure bridge	20	56BRIDGE
Enclosure divider	20	56DIVIDER
Single module gasket	20	56G1
Double module gasket	20	56G2
Push Button Lids		
<i>1 gang covers for all 22mm modules manufactured to BS4794/IEC337 and for mounting on standard 56E1 or larger enclosures. Available in Clear, Grey and Orange.</i>		
1 gang, single aperture	8	56L1221
1 gang, double aperture	8	56L1222
Mounting Kit and Accessories		
Mounting foot pair, stainless steel	1	56MF
Condensation breather (IP54 rated)	1	56D
Enclosure plug, Grey, 20mm	1	56PLUG20 #
Enclosure plug, Grey, 25mm	1	56PLUG25 #

Available in Grey only
 RO and RW priced 5% more than standard GY and CL.
 CG "Chemical Grey" priced 15% more than standard GY
 (not all cat no. are available in Chemical Grey).

56 Series™

Description	Ctn Qty	Item / Cat Number
Utility Boxes*		
<i>Dimensions all in mm. Available Grey lid (GY) or Clear lid (CL).</i>		
1 gang shallow (102x102x65)	8	U1S
1 gang (102x102x90)	8	U1
2 gang shallow (198x102x65)	4	U2S
2 gang (198x102x90)	4	U2
2 gang with gear tray (198x102x90)	2	U2T
3 gang (296x102x90)	2	U3
4 gang with gear tray (198x198x140)	1	U4T
6 gang with gear tray (296x198x140)	1	U6T

High Pressure Gaskets

56 Series™ gaskets for improved protection in high pressure wash down situations.

1 gang	20	56HPG1
2 gang – 1 piece cover	10	56HPG21
2 gang – 2 single covers	10	56HPG22

Not suitable for use with flush surrounds.



U1GY



U2TCL



U2GY



56HPG1

* Available in Grey base.
Available in Grey only.



56SO432C-CEE



BALS231



BALS31240



BALS21349

56 Series™

Description	Ctn Qty	Item / Cat Number
56 Series™/CEE SOCKETS IP57#		
3 pin, 16A 230V (suits Bals 21238)	1	56SO316-CEE
3 pin, 32A 230V (suits Bals 21240)	1	56SO332-CEE
4 pin, 16A 400V (suits Bals 21349)	1	56SO416-CEE
4 pin, 32A 400V (suits Bals 21351)	1	56SO432-CEE
5 pin, 16A 400V (suits Bals 21239)	1	56SO516-CEE
5 pin, 32A 400V (suits Bals 21241)	1	56SO532-CEE
Container socket, 4 pin, 32A 400V (suits Bals 21485)	1	56SO432C-CEE

Description	Ctn Qty	Item / Cat Number	Ctn Qty	Item / Cat Number
Bals CEE Norm Plugs and Connectors				

A range of protected industrial switchgear that conforms to international standards. Items are available in IP44 (splashproof) or IP67 (watertight) options. Further items, including 125 Amp accessories are available. Lead times apply.

	IP44		IP67	
Plugs, 230V Single Phase				
3 pin 16A	10	BALS211	1	BALS21238
3 pin 16A angled	10	BALS231		
3 pin 32A			1	BALS21240
Connectors, 230V Single Phase				
3 pin 16A		BALS311	1	BALS31240
3 pin 32A			1	BALS31244
Plugs, 400V 3 Phase				
4 pin 16A			1	BALS21349
4 pin 32A			1	BALS21351
5 pin 32A			1	BALS21241
International Container Equipment, 400V, 3 Phase, 4 pin 32A, IP67				
Plug				BALS21485*
Connector				BALS31423

* Suits 56SO432C-CEE.

For pin configurations refer to 56 Series™ Product Master – pgs 169-170.

Available in Grey only.

56 Series™

Description	Ctn Qty	Item / Cat Number
-------------	---------	-------------------

56 Series™ DOL Motor Starters

Available in Grey (GY) only.

DOL Starters, IP66, with enclosure

Schneider Electric's new range of 56 Series™ DOL Starters using TeSys Model D motor control gear. All base (enclosure) mount; all supplied with enclosure; all supplied less overload

4kW, 9A AC3, 240V, less o/load	1	56DOL9LOB
5.5kW, 12A AC3, 240V, less o/load	1	56DOL12LOB
7.5kW, 16A AC3, 240V, less o/load	1	56DOL16LOB
4kW, 9A AC3, 415V, less o/load	1	56DOL9LO
5.5kW, 12A AC3, 415V, less o/load	1	56DOL12LO
7.5kW, 16A AC3, 415V less o/load	1	56DOL16LO

TeSys Model D Thermal Overloads

Relay setting range (A)

0.63 — 1.0	1	LRD05
1.0 — 1.7	1	LRD06
1.6 — 2.5	1	LRD07
2.5 — 4.0	1	LRD08
4.0 — 6.0	1	LRD10
5.5 — 8.0	1	LRD12
7.0 — 10.0	1	LRD14
9.0 — 13.0	1	LRD16
12.0 — 18.0	1	LRD21

Coils and Contactors

Coils AC, to order set voltage specify ** with letter and number

24V: B7, 110V: F7, 240V: U7, 415V: N7	1	LXD1**
Contactors AC, to order set voltage specify ** with letter and number		
24V: B7, 110V: F7, 240V: U7, 415V: N7	1	LC1D09**
	1	LC1D12**
	1	LC1D18**



LRD21

For more information on the TeSys Model D accessories please refer to Section H in the latest Schneider Electric A4 Price Catalogue.



WMS110



WMS320



WMC310

WilcoROWCO Metal Clad Switchgear

Description	Ctn Qty	Item / Cat Number
WilcoROWCO Metal Clad Switchgear		
Switches Cast Aluminium IP66		
10A Single Pole 250V Size A	1	WMS110
10A Single Pole 2 way 250V	1	WMS110-TW
20A Single Pole 250V	1	WMS120
16A Single Pole 250V	1	WMS116
10A Double Pole 250V	1	WMS210
10A Three Pole 500V	1	WMS310
20A Three Pole 500V	1	WMS320
32A Three Pole 500V	1	WMS332
40A Three Pole 415V SB CVMT	1	WMS340
50A Three Pole 500V	1	WMS350
63A Three Pole 415V SB BSMT	1	WMS363
80A Three Pole 415V SC BSMT	1	WMS380
100A Three Pole 415V SC BSMT	1	WMS3100
125A Three Pole 415V SC BSMT	1	WMS3125
Other switch configurations up to 125A available on request – lead times apply		
Combination Switched Sockets Cast Aluminium IP66		
3 pin (flat) 10A Single Pole 250V	1	WMC310
3 pin (flat) 15A Single Pole 250V	1	WMC315
3 pin (round) 20A Single Pole 250V	1	WMC320
3 pin (round) 32A Single Pole 500V	1	WMC332
4 pin (round) 10A Three Pole 500V	1	WMC410
4 pin (round) 20A Three Pole 500V	1	WMC420
4 pin (round) 32A Three Pole 500V	1	WMC432
4 pin (round) 50A Three Pole 500V	1	WMC450
4 pin (round) 63A Three Pole 500V	1	WMC463
5 pin (round) 10A Three Pole 500V	1	WMC510
5 pin (round) 32A Three Pole 500V	1	WMC532

WilcoROWCO Metal Clad Switchgear

Description	Ctn Qty	Item / Cat Number
Combination Switched Sockets Cast Aluminium IP66		
5 pin (round) 50A Three Pole 500V	1	WMC550
5 pin (round) 63A Three Pole 500V	1	WMC563
Other switched socket configurations up to 5 pin 63A available on request – lead times apply		
Socket Outlets Cast Aluminium IP66		
1G 10A 3 pin (flat) 250V	1	WMB310
1G 15A 3 pin (flat) 250V	1	WMB315
1G 20A 3 pin (round) 250V	1	WMB320
1G 32A 3 pin (round) 250V	1	WMB332
1G 10A 4 pin (round) 500V	1	WMB410
1G 20A 4 pin (round) 500V	1	WMB420
1G 32A 4 pin (round) 500V	1	WMB432
1G 10A 5 pin (round) 500V	1	WMB510
1G 20A 5 pin (round) 500V	1	WMB520
1G 32A 5 pin (round) 500V	1	WMB532
1G 63A 4 pin (round) 500V	1	WMB463
Appliance Inlets Cast Aluminium IP 66		
1G 32A 3 pin (round) 250V	1	WMB332R
1G 32A 4 pin (round) 500V	1	WMB432R
1G 32A 5 pin (round) 500V	1	WMB532R
1G 63A 5 pin (round) 500V	1	WMB563R
Enclosures		
Junction Box 1x32 2X25mm entries	1	WMJB1
DIN Mounting MCB/RCD Enclosure 4 pole	1	WMDIN2



WMC563



WMB310



WMB332R



WMJB1



Universal Enclosures

Universal Enclosures

Enclosure Dimensions (HxWxD)

Item / Cat
Number

Thermoplastic Industrial Boxes - ABS

Check these features:

- > Material – ABS.
- > IP66/IPK07.
- > Temperature range -25...+60°C.
- > Low UV resistance.
- > Indoor use.



With Lid

74x74x54mm	Lid 10mm	NSYTBS775
89x89x54mm	Lid 10mm	NSYTBS885
116x74x62mm	Lid 10mm	NSYTBS1176
116x74x94mm	Lid 40mm	NSYTBS1179H
116x116x62mm	Lid 10mm	NSYTBS11116
116x116x133mm	Lid 80mm	NSYTBS111113H
138x93x72mm	Lid 20mm	NSYTBS1397
164x121x87mmv	Lid 20mm	NSYTBS16128
192x121x87mm	Lid 20mm	NSYTBS19128
192x121x105mm	Lid 40mm	NSYTBS191210H
192x164x87mm	Lid 20mm	NSYTBS19168
192x164x105mm	Lid 40mm	NSYTBS191610H
241x194x87mm	Lid 20mm	NSYTBS24198
241x194x105mm	Lid 40mm	NSYTBS241910H
241x194x127mm	Lid 60mm	NSYTBS241912H
291x241x88mm	Lid 20mm	NSYTBS29248
291x241x128mm	Lid 20mm	NSYTBS292412
291x241x128mm	Lid 60mm	NSYTBS292412H
291x241x168mm	Lid 60mm	NSYTBS292416H
341x291x128mm	Lid 20mm	NSYTBS342912
341x291x168mm	Lid 60mm	NSYTBS342916H

With Transparent Lid

138x93x72mm	Lid 20mm	NSYTBS1397T
164x121x87mmv	Lid 20mm	NSYTBS16128T
192x121x87mm	Lid 20mm	NSYTBS19128T
192x164x87mm	Lid 20mm	NSYTBS19168T
192x164x105mm	Lid 40mm	NSYTBS191610HT
241x194x105mm	Lid 40mm	NSYTBS241910HT
291x241x128mm	Lid 20mm	NSYTBS292412T
291x241x128mm	Lid 60mm	NSYTBS292412HT

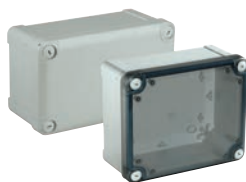

Universal Enclosures

Enclosure Dimensions (HxWxD)

Item / Cat
Number

Thermoplastic Industrial Boxes – Polycarbonate

- > IP66/IK08.
- > Temperature range -25...+80°C.
- > High UV resistance. 
- > Indoor/outdoor use.
- > High impact & temperature resistance for aggressive environments.

With Lid

74x74x54mm	Lid 10mm	NSYTBP775
89x89x54mm	Lid 10mm	NSYTBP885
116x74x62mm	Lid 10mm	NSYTBP1176
116x116x62mm	Lid 10mm	NSYTBP11116
138x93x72mm	Lid 20mm	NSYTBP1397
164x121x87mm	Lid 20mm	NSYTBP16128
192x121x87mm	Lid 20mm	NSYTBP19128
192x121x105mm	Lid 40mm	NSYTBP191210H
192x164x87mm	Lid 20mm	NSYTBP19168
192x164x105mm	Lid 40mm	NSYTBP191610H
241x194x87mm	Lid 20mm	NSYTBP24198
241x194x105mm	Lid 40mm	NSYTBP241910H
241x194x127mm	Lid 60mm	NSYTBP241912H
291x241x88mm	Lid 20mm	NSYTBP29248
291x241x128mm	Lid 20mm	NSYTBP292412
291x241x128mm	Lid 60mm	NSYTBP292412H
291x241x168mm	Lid 60mm	NSYTBP292416H
341x291x128mm	Lid 20mm	NSYTBP342912
341x291x168mm	Lid 60mm	NSYTBP342916H

With Transparent Lid

138x93x72mm	Lid 20mm	NSYTBP1397T
164x121x87mm	Lid 20mm	NSYTBP16128T
192x121x87mm	Lid 20mm	NSYTBP19128T
241x194x105mm	Lid 40mm	NSYTBP241910HT
291x241x128mm	Lid 20mm	NSYTBP292412T

Universal Enclosures

Description	Item / Cat Number
Thermoplastic Industrial Boxes – Accessories	
Insulating Mounting Plates	
192x164x2.5mm	NSYAMPA1916TB
241x194x2.5mm	NSYAMPA2419TB
291x241x2.5mm	NSYAMPA2924TB
341x291x2.5mm	NSYAMPA3429TB
Steel M/P are available	
Fixing Lugs	
To fit enclosures $\geq 116 \times 116$ mm. Vertical or Horizontal. Kit comprises of 4x lugs + screws	NSYAEFTB
Hinges	
To fit enclosures $\geq 138 \times 93$ mm. Permissible Load 10kg/m ² . Kit comprises of 2x hinges + screws. Made of Polycarbonate.	
To Suit Cover Height (mm).	
20	NSYAEDH20TB
40	NSYAEDH40TB



NSYAMPA1916TB



NSYAEFTB



NSYAEDH20TB



Conduit fittings, flexible & trunking



Conduits – Flexible

Description	Ctn Qty	Item / Cat Number
Corrugated Medium Duty PVC		
Grey PVC Medium Duty		
16mm – standard coil 50m	1	9016TCM
20mm – standard coil 50m	1	9020TCM
20mm – short coil 10m	5	9020TCM10
20mm – short coil 20m	1	9020TCM20
25mm – standard coil 50m	1	9025TCM
25mm – short coil 10m	5	9025TCM10
25mm – short coil 20m	1	9025TCM20
32mm – standard coil 25m	1	9032TCM
32mm – short coil 10m	5	9032TCM10
40mm – standard coil 25m	1	9040TCM
40mm – short coil 10m	5	9040TCM10
50mm – standard coil 25m	1	9050TCM
Grey PVC Medium Duty Sheathed		
20mm – standard coil 50m	1	9020CMS
20mm – short coil 20m	1	9020CMS20
25mm – standard coil 50m	1	9025CMS
25mm – short coil 20m	1	9025CMS20
32mm – standard coil 25m	1	9032CMS



9020TCM20



9020CMS20

Junction Boxes



240/20/1



240/20/2A



240/25/2



240/25/4



240L



249/25

Description	Ctn Qty	Item / Cat Number
-------------	---------	-------------------

Junction and Adaptable Boxes PVC

Available in Grey (GY), or Electric Orange (EO).

Round Junction Boxes – 20mm Entries

1 way	10	240/20/1
2 way through	10	240/20/2
2 way angle	10	240/20/2A *
3 way	10	240/20/3
4 way	10	240/20/4 *

Round Junction Boxes – 25mm Entries

1 way	10	240/25/1
2 way through	10	240/25/2
2 way angle	10	240/25/2A *
3 way	10	240/25/3
4 way	10	240/25/4 *

Round Junction Box Accessories

Lids to suit 16-20mm junction boxes	20	240L *
Junction box extension ring – 12mm	20	249/12 *
Junction box extension ring – 25mm	20	249/25

* Available in Grey (GY) only.

Junction Boxes

Available in Grey (GY) only.

Description	Ctn Qty	Item / Cat Number
Square Junction Boxes – 32mm Entries		
1 way	5	252/32/1
2 way through	5	252/32/2
2 way angle	5	252/32/2A
3 way	5	252/32/3
4 way	5	252/32/4
Square Junction Boxes – 40mm Entries		
1 way	5	252/40/1
2 way through	5	252/40/2
2 way angle	5	252/40/2A
3 way	5	252/40/3
4 way	5	252/40/4
Square Junction Boxes – 50mm Entries		
1 way	2	252/50/1
2 way through	2	252/50/2
3 way	2	252/50/3
4 way	2	252/50/4
Adaptable Boxes		
77 x 77 x 54mm (l x w x h)	5	265/1
108 x 108 x 76mm (l x w x h)	2	265/3
163 x 108 x 81mm (l x w x h)	1	265/4
211 x 108 x 81mm (l x w x h)	1	265/5
300 x 200 x 152mm (l x w x h) – with gasket	1	265/7





244/20



246/20

Inspecting Fittings

Description	Ctn Qty	Item / Cat Number
Inspection Fittings – PVC		
Inspection Elbows		
16mm	10	244/16 *
20mm	20	244/20
25mm	20	244/25
32mm	10	244/32
40mm	10	244/40 *
50mm	5	244/50 *
Inspection Tees		
16mm	10	246/16 *
20mm	20	246/20
25mm	10	246/25
32mm	5	246/32
40mm	5	246/40 *
50mm	2	246/50 *
Inspection Bends		
20mm – radius 41mm	20	247I20
25mm – radius 47mm	10	247I25
32mm – radius 64mm	5	247I32

*Available in Grey (GY) only.

Solid Fittings

Description	Ctn Qty	Item / Cat Number
Solid Fittings – PVC		
Conduit Plugs – Plain		
16mm	50	220/16 *
20mm	50	220/20 *
25mm	50	220/25
Conduit Plugs – Screwed		
20mm	50	220S20 *
25mm	50	220S25 *
32mm	20	220S32 *
40mm	20	220S40 *
50mm	20	220S50 *
PVC Couplings		
16mm	20	242/16 *
20mm	50	242/20
25mm	20	242/25
32mm	20	242/32
40mm	10	242/40
50mm	5	242/50
Nipples		
16mm	50	243/16 *
20mm	50	243/20 *
25mm	50	243/25 *
32mm	20	243/32 *
40mm	20	243/40 *
50mm	10	243/50 *



220/20



220S20



242/20



243/20

*Available in Grey (GY) only.



245/20



247/20



247L25



247LH20

Solid Fittings

Description	Ctn Qty	Item / Cat Number
Solid Elbows		
16mm	20	245/16
20mm	20	245/20
25mm	20	245/25
Bends		
16mm – radius 41mm	10	247/16 *
20mm – radius 47mm	20	247/20
25mm – radius 64mm	20	247/25
32mm – radius 83mm	10	247/32
40mm – radius 100mm	5	247/40 *
50mm – radius 120mm	5	247/50 *
90 Degree Sweep Bends		
20mm – radius 150mm	10	247L20 #
25mm – radius 150mm	10	247L25
32mm – radius 312mm	10	247L32
40mm – radius 312mm	5	247L40 *
50mm – radius 320mm	5	247L50 *
45 Degree Sweep Bends		
20mm – radius 150mm	10	247LH20 #
25mm – radius 150mm	10	247LH25
32mm – radius 312mm	5	247LH32
40mm – radius 312mm	5	247LH40 *
50mm – radius 320mm	5	247LH50 *

*Available in Grey (GY) only.

Available in Orange (EO) only.

Fittings

Description	Ctn Qty	Item / Cat Number
Expansion Couplings – Slip Type		
16mm – radius 145mm	20	251/16
20mm – radius 157mm	50	251/20 *
25mm – radius 270mm	20	251/25 *
32mm – radius 280mm	10	251/32
40mm – radius 310mm	10	251/40 *
Expansion Couplings – Flexible		
20mm	50	F251/20 *
25mm	20	F251/25 *
32mm	10	F251/32 *
40mm	10	F251/40 *
50mm	5	F251/50 *
Plain To Screwed Couplings – Junction Box Entries		
16mm	20	258/16 *
20mm	50	258/20
25mm	20	258/25
32mm	10	258/32
40mm	10	258/40 *
50mm	10	258/50 *



*Available in Grey (GY) only.



262/25-E0



263/20-GY



264/1M



264/2SM-GY

Fittings

Description	Ctn Qty	Item / Cat Number
Conduit Caps		
20mm	50	262/20
25mm	50	262/25
32mm	20	262/32
40mm	20	262/40 *
50mm	10	262/50 *
Adaptors – Plain To Screwed Conduit		
16mm	20	263/16 *
20mm	50	263/20
25mm	50	263/25
32mm	20	263/32
40mm	10	263/40 *
50mm	10	263/50 *
Plain Reducers		
20mm – 16mm	50	264/1M *
25mm – 20mm	50	264/2M
32mm – 25mm	50	264/3M
40mm – 32mm	20	264/4M
50mm – 40mm	10	264/5M
Screwed Reducers		
20mm – 16mm	50	264/1SM *
25mm – 20mm	50	264/2SM *
32mm – 25mm	50	264/3SM *
40mm – 32mm	20	264/4SM *
50mm – 40mm	10	264/5SM *

*Available in Grey (GY) only.

Fittings

Description	Ctn Qty	Item / Cat Number
Male Bushes		
16mm	20	281/16 *
20mm	50	281/20 *
25mm	50	281/25 *
32mm	50	281/32 *
40mm	20	281/40 *
50mm	10	281/50 *
Female Bushes		
16mm	20	281F16 *
20mm	50	281F20 *
25mm	50	281F25 *
32mm	50	281F32 *
40mm	20	281F40 *
50mm	10	281F50 *
Hexagonal Lock Nuts		
16mm	50	259/16 *
20mm	100	259/20
25mm	50	259/25
32mm	50	259/32
40mm	20	259/40
50mm	20	259/50
Screwed Lock Rings		
16mm	100	260/16 *
20mm	100	260/20 *
25mm	50	260/25 *
32mm	50	260/32 *
40mm	20	260/40 *
50mm	20	260/50 *



*Available in Grey (GY) only.

Fixing Accessories



261/20



261E20



261S20



280/25

Description	Ctn Qty	Item / Cat Number
Fixing Accessories, PVC		
Saddles		
16mm	50	261/16 *
20mm	100	261/20
25mm	100	261/25
32mm	50	261/32
40mm	50	261/40
50mm	20	261/50
Saddle Extension Spacer		
20mm	20	261E20 *
25mm	20	261E25 *
Conduit Saddle Spacer		
20mm	50	261S20 *
25mm	20	261S25 *
Conduit Clips and Mounting Channel		
Conduit clip 16mm	20	280/16 *
Conduit clip 20mm	50	280/20 *
Conduit clip 25mm	50	280/25 *
Conduit clip 32mm	20	280/32 *
Conduit clip 40mm	20	280/40 *
Conduit clip 50mm	10	280/50 *

*Available in Grey (GY) only.

Corrugated Fittings

Description	Ctn Qty	Item / Cat Number
Corrugated Fittings PVC		
Adaptor – Screwed to Corrugated Conduit		
20mm screwed to 20mm corrugated (clip adaptor)	50	263/20C *
Straight Glands		
16mm	10	279C16 *
20mm	20	279C20 *
25mm	20	279C25 *
32mm	10	279C32 *
40mm	5	279C40 *
50mm	5	279C50 *
Angled Glands (90 Degree)		
16mm	10	279AC16
20mm	20	279AC20
25mm	10	279AC25
32mm	5	279AC32



263/20C



279C20



279AC20

*Available in Grey (GY) only.



MDEAP1610RT-WE



900/25/16



900/40/25/2-WE



900/25/16C-WE



900/25/16EI



900/25/16EE

Duct – Non-Metallic

Description	Ctn Qty	Item / Cat Number
-------------	---------	-------------------

Mini Duct, PVC

Available in White Electric (WE) only.

Standard Duct – 4 Metre Lengths

16 x 10mm rectangular	20	900/16/10
16 x 16mm square	20	900/16/16
25 x 16mm rectangular	20	900/25/16
25 x 25mm square	20	900/25/25
40 x 16mm rectangular	10	900/40/16
40 x 25mm rectangular	10	900/40/25
40 x 25mm twin compartment rectangular	10	900/40/25/2
60 x 40mm rectangular	10	900/60/40

Mini Duct Fittings

Couplings

16 x 16mm	20	900/16/16C
25 x 16mm	20	900/25/16C
40 x 25mm	20	900/40/25C

Internal Elbows

16 x 16mm internal elbow	10	900/16/16EI
25 x 16mm internal elbow	10	900/25/16EI
40 x 25mm internal elbow	10	900/40/25EI

External Elbows

16 x 16mm external elbow	10	900/16/16EE
25 x 16mm external elbow	10	900/25/16EE
40 x 25mm external elbow	10	900/40/25EE

Duct – Non-Metallic

Description	Ctn Qty	Item / Cat Number
Flat Elbows		
16 x 16mm flat elbow	10	900/16/16E
25 x 16mm flat elbow	10	900/25/16E
40 x 25mm flat elbow	5	900/40/25E
Tees		
25 x 16mm side tee	10	900/25/16TS
16 x 16mm flat tee	10	900/16/16T
25 x 16mm flat tee	10	900/25/16T
25 x 16mm right intersection tee	10	900/25/16TR
25 x 16mm left intersection tee	10	900/25/16TL
End Plugs		
16 x 16mm	20	900/16/16P
25 x 16mm	20	900/25/16P
40 x 25mm	20	900/40/25P
Adaptors		
25 x 16mm ducting to 20mm conduit	10	900/25/16CA
25 x 25mm ducting to 25 x 16mm	10	900/25A25
40 x 25mm ducting to 25 x 16mm	10	900/40A25
Mounting Blocks		
Round surface mounting block – 50mm mounting centres	10	900RMB
Skirting mounting block single gang – 78mm mounting centres	10	900SKMB
Standard size mounting block single gang	10	900SPBP
Standard size surface mount block single gang – 84mm mounting centres	5	900SPMB
Adhesive Tapes for Mini Duct		
50m x 12mm wide	1	900AT12
50m x 18mm wide	1	900AT18
50m x 24mm wide	1	900AT24



900/16/16E



900/25/16TS



900/16/16P



900/25/16CA



900RMB-WE



900SPMB-WE



900AT18



900/50/50



900/75/50EI-GY



900/100/50EE-GY

Duct – Non-Metallic

Description	Ctn Qty	Item / Cat Number
Maxi Duct, PVC		
<i>Available in Grey (GY) only.</i>		
4 Metre Lengths		
50 x 50mm	1	900/50/50
75 x 50mm	1	900/75/50
75 x 75mm	1	900/75/75
100 x 75mm	1	900/100/75
100 x 100mm	1	900/100/100
150 x 75mm	1	900/150/75
Internal Elbows		
50 x 50mm	1	900/50/50EI
75 x 50mm	1	900/75/50EI
100 x 50mm	1	900/100/50EI
75 x 75mm	1	900/75/75EI
100 x 75mm	1	900/100/75EI
100 x 100mm	1	900/100/100EI
External Elbows		
50 x 50mm	1	900/50/50EE
75 x 50mm	1	900/75/50EE
100 x 50mm	1	900/100/50EE
75 x 75mm	1	900/75/75EE
100 x 75mm	1	900/100/75EE
100 x 100mm	1	900/100/100EE

Duct – Non-Metallic

Description	Ctn Qty	Item / Cat Number
Maxi Duct Fittings		
Flat Elbows		
50 x 50mm	1	900/50/50E
75 x 50mm	1	900/75/50E
100 x 50mm	1	900/100/50E
75 x 75mm	1	900/75/75E
100 x 75mm	1	900/100/75E
100 x 100mm	1	900/100/100E
Tees		
50 x 50mm	1	900/50/50T
75 x 50mm	1	900/75/50T
100 x 50mm	1	900/100/50T
75 x 75mm	1	900/75/75T
100 x 75mm	1	900/100/75T
100 x 100mm	1	900/100/100T
End Plugs		
50 x 50mm	5	900/50/50P
75 x 50mm	5	900/75/50P
100 x 50mm	5	900/100/50P
75 x 75mm	5	900/75/75P
100 x 75mm	5	900/100/75P
100 x 100mm	5	900/100/100P
Connector Clip		
For all sizes except 50 x 50	10	900CC
Separators		
50mm clip-in, suit 100 x 50	1	900D50S *
75mm clip-in, suit 100 x 75	1	900D75S
100mm clip-in, suit 100 x 100	1	900D100S
Duct Cutter		
Multi-purpose cutter suits mini duct	5	900TC

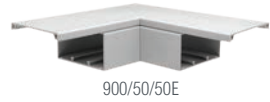

* Available in Electric White (WE) only.

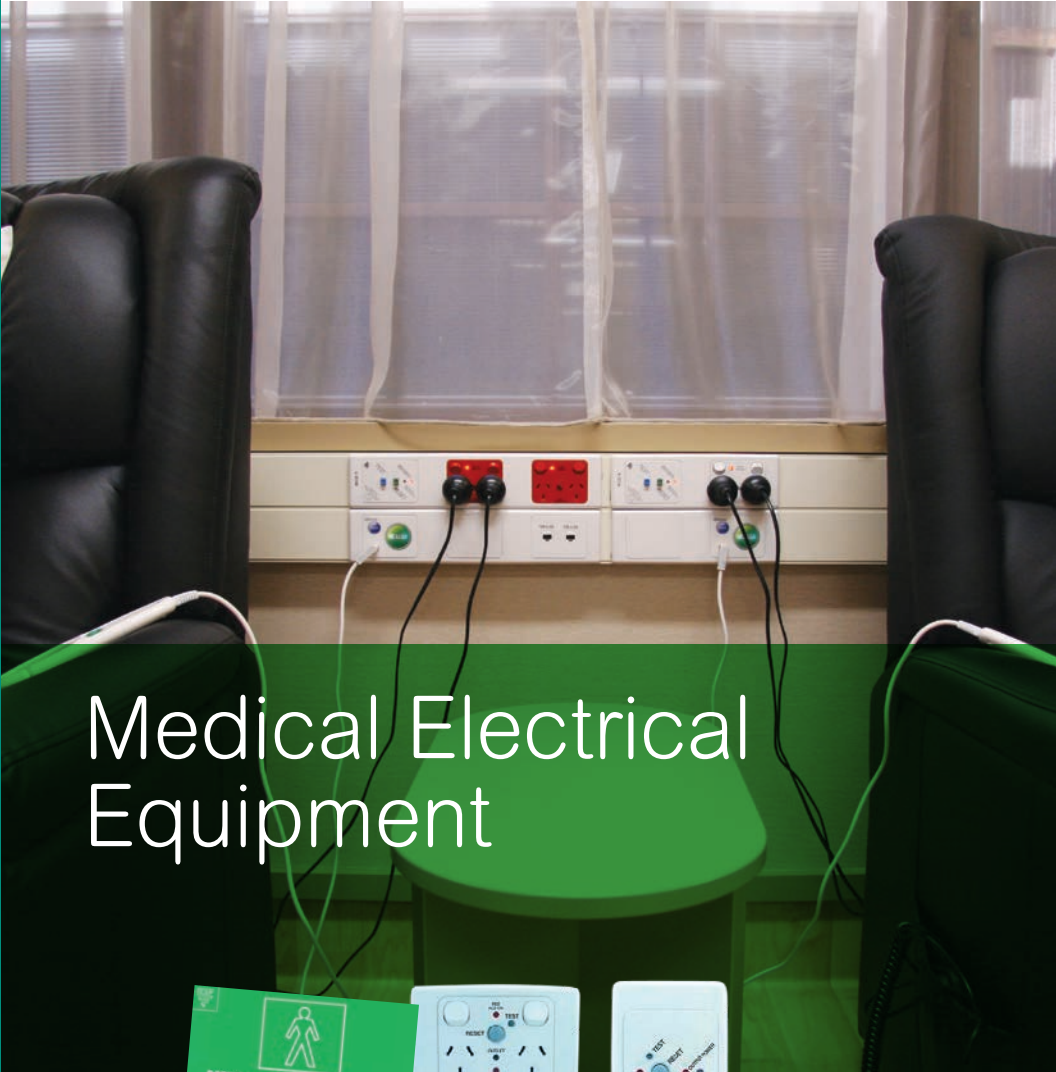

Medical Electrical Equipment



Medical Electrical Equipment

The Tools of a Specialist with a product history dating back over 30 years, the Medilec hospital product range comprises a wide range of electrical equipment for patient treatment areas of hospitals, medical and dental practices. Medical Service Panels
The Medilec range consists of a number of different styles to suit the various needs of customers. From flush or surface mounted systems that are available in stainless steel or powder coated finishes, through to the very economical and modern moulded system based on the popular 2000 Series.

Electrocution Protection Equipment Medilec has a range of Electrocution Protection Equipment to meet all the requirements in patient treatment areas. Products include Line Isolation & Overload Monitors (LIOM), Isolation Transformers, Residual Current Devices (RCD), and Equipotential Junctions. Specialist Electrical Accessories Medilec has a range of accessories to meet all the requirements in patient treatment areas, including coloured socket outlets with power available indication, portable RCD protected socket outlets and area classification signs.

Medilec – Medical Electrical Equipment

ML2000 Series – Flush Mount Moulded

The ML2000 Moulded Series can either be purchased as individual catalogue items or as a complete medical service panel. The complete panel is made to order to meet the customer's individual requirements and can incorporate various services including power, lighting control, nurse call, data, phone etc.

ML2164 Series – Flush Mount Metal Plate

The ML2164 Flush Mount Metal Plate Series can either be purchased as individual catalogue items or as a complete medical service panel. The complete panel is made to order to meet the customers individual requirements and can incorporate various services including power, lighting control, nurse call, data, phone etc.

ESP Series – Flush Mount Metal Plate

The ESP Surface Flush Series can either be purchased as individual catalogue items or as a custom medical service panel. The custom panel is made to order to meet the customers individual requirements and can incorporate various services including power, lighting control, nurse call, data, phone etc.

Please note that the standard switched outlet panels detailed in this section require an additional power available neon if they are going to be protected by an RCD. All items require an additional recessed wall box.

ML2000 Series

Description	Ctn Qty	Item / Cat Number
-------------	---------	-------------------

This range is available in White Electric (WE), Red (RD) and Dark Blue (DB).

Residual Current Devices (RCDs)

250V 20A 10mA horizontal/Vertical	1	ML2031RCD10
-----------------------------------	---	-------------



ML2031RCD10

Socket Outlets, Switched

Vertical Mount

S/Pow. O/Let c/w PA neon & RCD label	5	ML2015V
--------------------------------------	---	---------

S/Pow. O/Let c/w PA neon, RCD label, & circ ID	5	ML2015VI
--	---	----------

S/Pow. O/Let c/w PA neon, RCD label, & circ ID 15A	5	ML2015/15VI
--	---	-------------

Twin/Pow. O/Let c/w PA neon & RCD label	5	ML2025V
---	---	---------

Twin/Pow. O/Let c/w PA neon, RCD label, & circ ID	5	ML2025VI
---	---	----------



ML2015V



ML2025V



ML2025VI

Horizontal Mount

S/Pow. O/Let c/w PA neon & RCD label	5	ML2015
--------------------------------------	---	--------

S/Pow. O/Let c/w PA neon, RCD label, & circ ID	5	ML2015I
--	---	---------

S/Pow. O/Let c/w PA neon, RCD label, & circ ID 15A	5	ML2015/15I
--	---	------------

Twin/Pow. O/Let c/w PA neon & RCD label	5	ML2025
---	---	--------

Twin/Pow. O/Let c/w PA neon, RCD label, & circ ID	5	ML2025I
---	---	---------



ML2025



ML2025I

Cleaner Model – Horizontal Mount

S/Pow. O/Let c/w Cleaner label	5	ML2015C *
--------------------------------	---	-----------

S/Pow. O/Let c/w Cleaner label, 15A	5	ML2015/15C *
-------------------------------------	---	--------------

Twin/Pow. O/Let c/w Cleaner label	5	ML2025C *
-----------------------------------	---	-----------



ML2015C



ML2025C

* Available in Beige only.

ML2000 Series



ML2025RCD10



ML2000



POAG-ID6



ML2031VR01



ML2164E35



ML2164

Description	Ctn Qty	Item / Cat Number
-------------	---------	-------------------

Socket Outlets, RCD Protected

Horizontal Mount

Twin/Pow. 0/let with 250V 10mA RCD	1	ML2025RCD10
------------------------------------	---	-------------

Cleaner Model – Horizontal Mount

Twin/Pow. 0/let with 250V 10mA RCD c/w Cleaner label	1	ML2025RCD10C *
--	---	----------------

Specialised Medical Services Panels

Medical Services Panel	1	ML2000
------------------------	---	--------

Please specify required components at time of order.

Equipotential Earthing Poag

POAG flush mounted EP socket	1	POAG-ID6
------------------------------	---	----------

Equipotential Earthing Studs

Vertical Mount

Single gang EP stud	1	ML2031VR01
---------------------	---	------------

Double gang EP stud	1	ML2032VR02
---------------------	---	------------

Equipotential Junctions

14 tunnels and 1 line tap (suit 3 gang wall box)	1	ML2164E35
--	---	-----------

3 gang wallbox	1	ML2164/3W
----------------	---	-----------

Specialised Metal Medical Services Panels

ML2164 Series Medical Services Panels	1	ML2164
---------------------------------------	---	--------

Please specify required components at time of order.

* Available in Beige only.

Accessories

Description	Ctn Qty	Item / Cat Number
RCD Modules – 10mA		
240VAC 10A 10mA RCD/MCB module	1	E01CNN10
240VAC 16A 10mA RCD/MCB module	1	E01CNN16
240VAC 20A 10mA RCD/MCB module	1	E01CNN20
240VAC 32A 10mA RCD/MCB module	1	E01CNN32
Equipotential Earth Stud		
Equipotential earth stud	1	R01
Power Available Neon		
Amber power available neon with F30Z1.5 mounting clip	1	N01
RCD Relay		
240VAC 10mA/10ms with mounting bracket	1	E03/10/10
Area Classification Signs		
Cardiac protected sign	1	SIGN/CPA
Body protected sign	1	SIGN/BPA
Electronic RCD/MCB, C-Curve, Type A, 10ka, 240V		
240V 10A – 10mA 1-phase+N, 10kA, 2 modules wide	1	4RCBE210/10
240V 16A – 10mA 1-phase+N, 10kA, 2 modules wide	1	4RCBE216/10
240V 20A – 10mA 1-phase+N, 10kA, 2 modules wide	1	4RCBE220/10
240V 32A – 10mA 1-phase+N, 10kA, 2 modules wide	1	4RCBE232/10
240V 40A – 10mA 1-phase+N, 10kA, 2 modules wide	1	4RCBE240/10



E01CNN10



R01



N01



E03/10/10



SIGN/BPA



SIGN/CPA



4RCBE220/10

2000 Series



2031VAUSMT-WE



2032VH-WE



2036VH-WE



2000/2



2000H2



2000/4

Description	Ctn Qty	Item / Cat Number
Flush Switches		
Switch 1 gang 250V 20A/16AX	10	2031VAUSMT
Switch 2 gang 250V 20A/16AX	10	2032VAUSM
Switch 3 gang 250V 20A/16AX	10	2033VAUSM

Grid Plates and Surrounds

Flush Surrounds and Grids – Standard Size – Horizontal/Vertical Mount

Flush surround and blank grid	10	2031VX
Flush surround and 1 gang grid	10	2031VH
Flush surround and 2 gang grid	10	2032VH
Flush surround and 3 gang grid	10	2033VH
Flush surround and 4 gang grid	10	2034VH
Flush surround and 5 gang grid	5	2035VH
Flush surround and 6 gang grid	5	2036VH
Flush surround only	10	2000

Flush Surrounds Two Gang – Standard Size

2 gang curved sided	10	2000/2
2 gang horizontal	5	2000H2

Flush Surrounds Three Gang – Standard Size

3 gang curved sided	5	2000/3
3 gang horizontal	5	2000H3

Flush Surrounds Four Gang – Standard Size

4 gang curved sided flush surround	5	2000/4
------------------------------------	---	--------

Available in White Electric (WE) only.

Socket Outlets – 2000 Series

Description	Ctn Qty	Item / Cat Number
Socket Outlets, Switched Horizontal		
Single – Standard Size – Horizontal Mount		
Power outlet single 250V 10A	10	2015
Power outlet single 250V 15A	10	2015/15
Power outlet single 250V 20A	5	2015/20
Power outlet single 250V 10A with removable extra switch and shutters	5	2015XS
Twin – Standard Size – Horizontal Mount		
Power outlet double 250V 10A	10	2025
Power outlet double 250V 10A with removable extra switch	5	2025XA
Power outlet double 250V 15A	5	2025/15

Socket Outlets, Switched Vertical Mount		
Single – Standard Size – Vertical Mount		
Power outlet single 250V 10A	5	2015V
Twin – Standard Size – Vertical Mount		
Power outlet double 250V 10A – 1 piece base	5	2025V
Power outlet double 250V 10A with removable switch	5	2025VXA



2015



2015XS



2025XA



2025V

Accessories – 2000 Series



2157/2

Wall Boxes – Metal		
Wall box 2 gang to suit 2000/2 series	5	2157/2
Wall box 2 gang to suit 2000H2 series	5	2157H2

Notes





Protect yourself
and your assets



The easy economical way to safeguard yourself when working with electricity

Powerguard protects both your people and your equipment from harmful shocks around the home and building site

Accurate electronic technology is used to constantly monitor the balance of current flow to detect even minor leakage in power tools, extension leads and others such as electric lawnmowers, trimmers, BBQ's and temporary party lighting as well as pool vacuums, filters, spas and any other outdoor equipment. Dampness, faulty wiring, frayed cords, damage and other hazards in the workshop, home or outdoors can all be greatly protected against causing a lethal situation.

30mA and 10mA versions available for Equipment and Person Protection applications, in either white (WH) or Orange (OR). Indoor, Power Socket Outlet and Plugtop versions as well as outdoor, Extension Leads, Re-wirable and Portable devices.



691RCD-30



696RCD-30



695RCD-30

Powerguard RCD protection

Description	Ctn Qty	Item / Cat Number
Powerguard Fixed Wired RCDs, 30mA and 10mA		
RCD vertical switched socket 10A, 30mA	1	691RCD-30 *
RCD vertical switched socket 10A, 10mA	1	691RCD-10 #
RCD horizontal double, switched socket 10A 30mA	1	695RCD-30 #
RCD horizontal double, switched socket 10A 10mA	1	695RCD-10 #
Plate mounted RCD 20A, 10mA	1	696RCD-10 #
Plate mounted RCD 20A, 30mA	1	696RCD-30 #

Note: PDL Powerguard 10mA RCDs are suitable for use in the medical industry.

Available in White only.

* Available in White and Black only.

Powerguard RCD protection

Description	Ctn Qty	Item / Cat Number
Fixed Wired IP66 Protected RCDs		
Earth leakage only:		
20A RCD, 30mA	4	56RCD20-30
Earth leakage only with socket outlet:		
3 pin 10A	4	56C310RCD-30
3 pin 16A	4	56C316RCD-30 [^]
3 pin 20A	4	56C320RCD-30
Modular and Flexible RCD & RCBO Protection IP66		
The 56 Series™ and Domae enable RCD protection from 1 to 16 gang outlets. The 56 Series 4 pole width DIN mount cover enables RCCB and RCBO protection to be fitted in conjunction with single or multiple socket outlets.		
DIN Mount Cover, 4 Pole Width (72mm)	2	56CB4 [*]
<i>Refer to 56 Series – section J – for other product details.</i>		



56RCD20-30



56C310RCD-30



[^] Compatible with Bals 211 and Bals 21238 plugs.

^{*} The 56CB4 comes complete with DIN rail mount kit, and fits to a 56E2 or larger.



951



952



955

Powerguard RCD protection

Description	Ctn Qty	Item / Cat Number
Powerguard Portable RCDs, 30mA, 10mA		
RCD plug-in adaptor, white, 10A, 30mA	5	951
RCD plug, white, 10A, IP3X, 30mA	5	952
In-line RCD cordsets:		
2m cord, 10A, IP33, 30mA	5	955
Rewirable cordset, 16A, 30mA, IP56, orange	100	955RW
Rewirable cordset, 16A, 10mA, IP56, white	100	955RW10



RCD protection

Description	Ctn Qty	Item / Cat Number
RCDs		
RCCBs, DIN Mount		
30mA 2P 40A	6	DOM16695
30mA 2P 63A	6	DOM16696
RCD/MCBs RCBO, Two Pole, DIN Mount		
30mA 10A, 6kA	6	DOM19802
30mA 16A, 6kA	6	DOM19803
30mA 20A, 6kA	6	DOM19804
30mA 25A, 6kA	6	DOM19805
30mA 32A, 6kA	6	DOM19806
30mA 40A, 6kA	6	DOM19807
RCD/MCB's RCBO, Two Pole DIN Mount (Slimline)		
<i>Single pole width (18mm), double pole switching</i>		
AD63 K C 6A 1PN 30mA 6kA RCBO	12	DOM12529
AD63 K C 10A 1PN 30mA 6kA RCBO	12	DOM12530
AD63 K C 16A 1PN 30mA 6kA RCBO	12	DOM12531
AD63 K C 20A 1PN 30mA 6kA RCBO	12	DOM12532
AD63 K C 25A 1PN 30mA 6kA RCBO	12	DOM12533
AD63 K C 32A 1PN 30mA 6kA RCBO	12	DOM12534



DOM16695



DOM19803



DOM12529

EV B type Earth Leakage Protection

Choosing the correct RCD type for the application is critical

Electric vehicles are becoming increasingly popular, and charging stations need the appropriate protection for all users. Especially given that these stations are often located outside where they are exposed to the rain and operated daily by untrained users.

For Electric Vehicle Charging Type B Earth Leakage Protection is what you need to provide Safe and Efficient People Protection.



RCCB for EV		
Description	Ctn Qty	Item / Cat Number
16A 2 poles 30mA	1	A9Z51216
25A 2 poles 30mA	1	A9Z51225
40A 2 poles 30mA	1	A9Z51240
40A 4 poles 30mA	1	A9Z51440
63A 4 poles 30mA	1	A9Z51463



A9Z51216



MODEL ILD

IP Ratings

1st Figure

Protection against solid objects.



Protected against solid bodies greater than 50mm (e.g. involuntary hand contact).

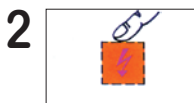

Protected against solid bodies larger than 12mm (e.g. finger of the hand).

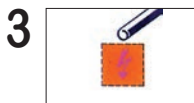

Protected against solid bodies larger than 2.5mm (e.g. tools, wire).



Protected against solid bodies larger than 1mm (e.g. fine tools and small wires).

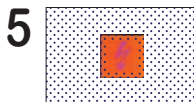

Protected against dust (no harmful deposits).

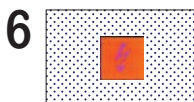

Completely protected against dust.

2nd Figure

Protection against harmful ingress of water.

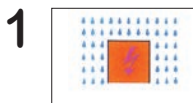

Protected against vertically falling drops of water.

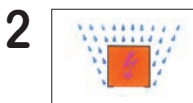

Protected against drops of water falling at up to 15° from the vertical.

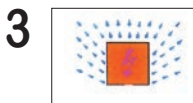

Protected against spraying water at up to 60° from the vertical.

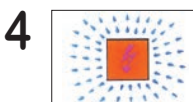

Protected against splashing water from all directions.



Protected against jets of water from all directions.



Protected against jets of water of similar force to heavy seas.

Wiring Diagrams

PDL Iconic

Iconic – 2 way switching with LED indication

(Switch mech LED indicator ON when switch is OFF)

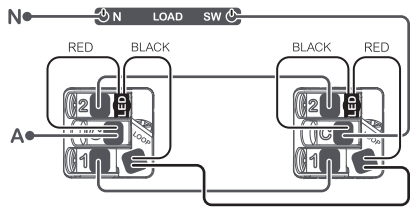

Iconic – Multiway switching with LED indication

(Switch mech LED indicator ON when switch is OFF)

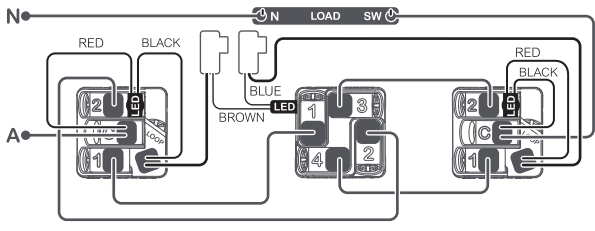

Wiring Diagrams

PDL Iconic - Pushbutton Electronic Switch / Timer / Timeclock

Note – Push Button Electronic Switch output is latching; Both Timers & Timeclocks can also be configured to be used as a simple push button with output either latching or momentary.

- 2 wire products – use when no neutral is available.
Minimum load ~10W, maximum 350W. If mech LED starts to flicker use a load correction device (S31LCDA)
- 3 wire products – recommended over 2 wire products.
No minimum load, higher maximum loads - 6A or 10A products. Uses an internal latching relay which consumes no power – only during change of state.

3 wire 6A – 346PB## Timeclock

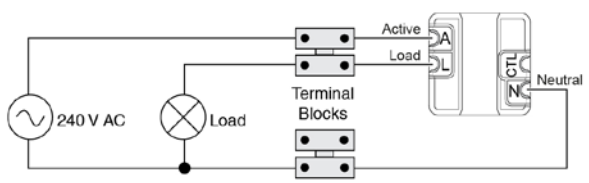

2 wire 350W – 356PBSM## Push Button, 348PBTM## Timer

(OPTIONAL - ControlLink Push Button 356PBSS)

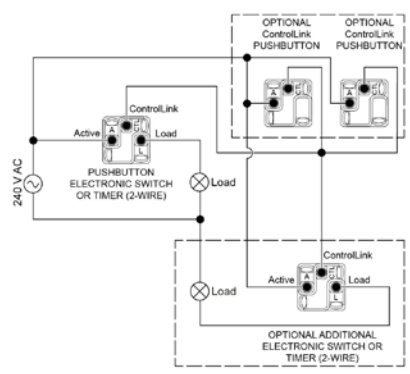

Wiring Diagrams

10A units – 356PB10MBTW-VW

(OPTIONAL - ControlLink Push Button 356PBSS)

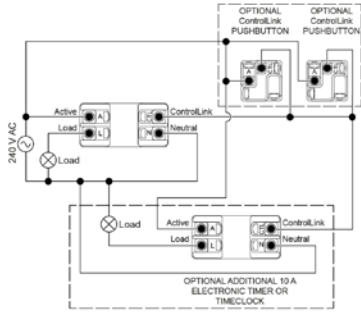

Wiring Diagrams

Electrical Specifications – Iconic - Pushbutton Electronic Switch

Parameter	2-wire 350 W Units	3-wire 6 A Units	3-wire 10 A Units
Nominal Operating Voltage	220-240 V AC		
Nominal Operating Frequency	50 Hz		
Minimum Load Rating	10W	0A	0A
Maximum Load Rating	350 W	6 A	10A
Switching Technique	Semiconductor	Relay	Relay
Wiring Configuration:			
Incandescent Loads	350 W	6 A	10 A
MV Halogen Loads	350 W	6 A	10 A
Electronic LV Lighting Transformers	350 W	6 A	10 A
Iron Core LV Lighting Transformers (EI and Toroidal Types)	350 W	6 A	10 A
Linear Fluorescent Ballasts	250 W	6 A	10 A
Compact Fluorescent Loads	250 W	6 A	10 A
LED Lighting Drivers	350 W (Dimmable) 250 W (Non-Dim.)	6 A	10 A
Inductive Loads (e.g. Small Motors such as Ceiling Exhaust Fans)	Not Compatible	6 A @ 0.8 Power Factor	10 A @ 0.8 Power Factor
Purely Resistive Loads	350 W	6 A	15 A
Voltage / Frequency Stability	YES		
Over-current / Thermal Fuse Protection	YES	NO	NO
Over-temperature Protection	YES		
Short Circuit Protection	YES	NO	NO
BLE-enabled	NO	YES	YES
LED Indicator	YES		
Multi-Way Control	YES		

*Minimum load is approximately 10W, this can be higher depending on different products. If in doubt use Clipsal downlights - these are tested to 10W minimum loads on 2 wire products.

Multi-Gang Derating

For applications where Iconic Pushbutton Electronic Switches, Timers and Time-clocks are multi-ganged, derate the maximum load rating of each unit according to the derating table shown below.

Primary Mechanisms per Plate	Max. Load per Primary Mechanism		
	(2-Wire Units)	(6 A Units)	(10 A Units)
1	350 W	6 A	10 A
2	250 W	4.5 A	7.5 A
3	220 W	4 A	6.5 A
4	175 W	3 A	N/A
5	120 W	2 A	N/A
6	100 W	1.5 A	N/A

NOTICE: Only Primary Units need be derated. Multi-Way Remote Units on the same plate can be ignored for the purpose of multi-gang derating.

Wiring Diagrams

PDL Iconic Dimmers

Dimmer Wiring – Two Way

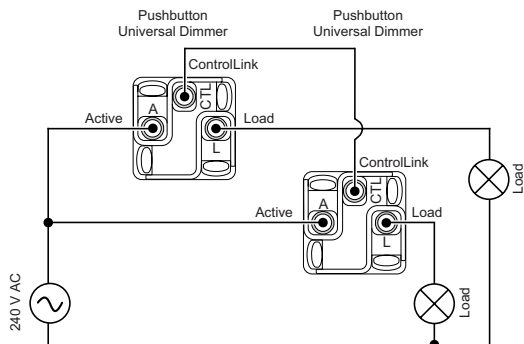

Dimmer Wiring – Two Way using ControlLink

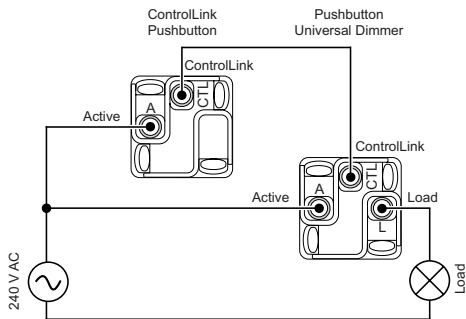

Dimmer Wiring – Two Way using ControlLink

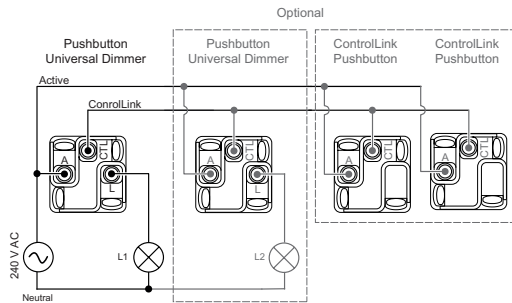

Wiring Diagrams

PDL Iconic Dimmers

Dimmer Wiring – Three Way using x1 ControlLink

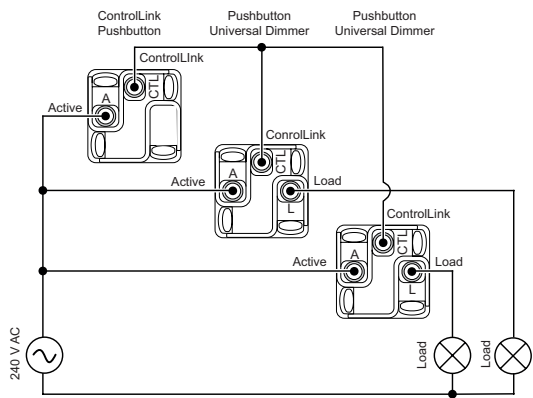

Dimmer Wiring – Three way using x2 ControlLink

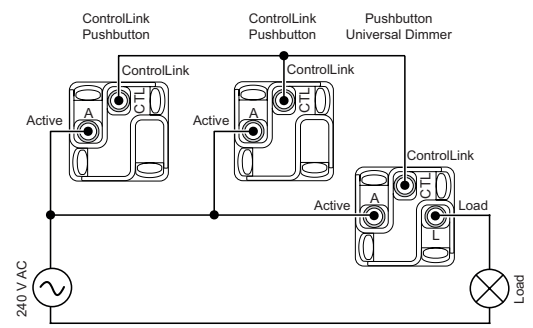

Wiring Diagrams

680M16N and 680M16NPS One way switches with neon (rear view)

Neon permanently ON

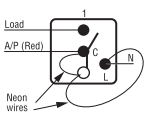

Neon ON, switch ON (indicator)

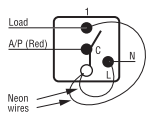

678M16 Intermediate Switch Rear view of switch modules

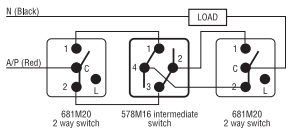

Any number of intermediate switches can be wired between the 2 way switches.

2 Way Switch used as an Intermediate via 600RM

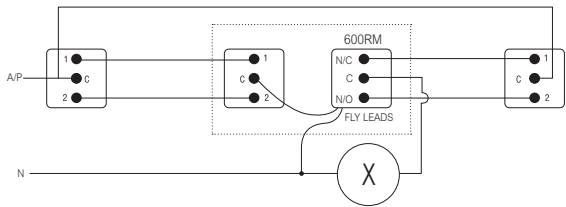

*600RM can be placed into wall/flush box and used with any plate range.

617M2 BT Telephone Sockets

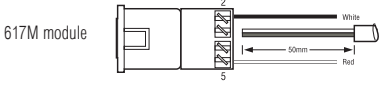

Use 500TT tool to insert wires (Ø 0.5mm) to IDC terminals, max one wire per terminal slot.

619MD Standard wiring for RJ45 Jack (Jack face shown)

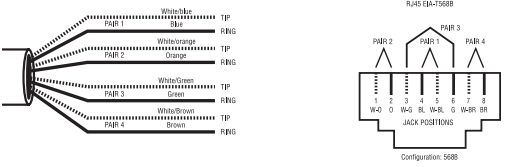

Wiring Diagrams

654 Dimmer and 654M Dimmer Module One way circuit

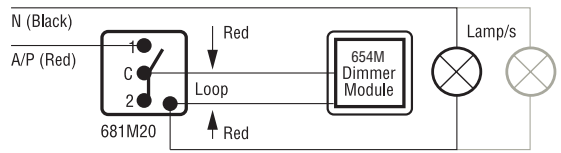

654 Dimmer and 654M Dimmer Module Two way circuit

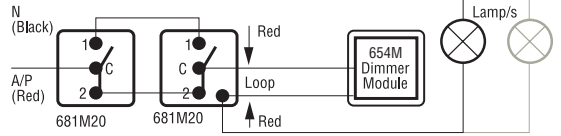

625F/625FM Fan Speed Control

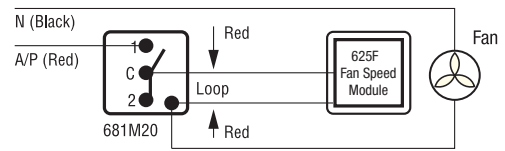

632 Time Delay Module

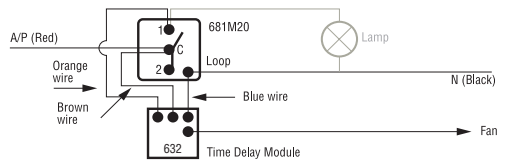

646R24 Timer

Load ON when tappets down

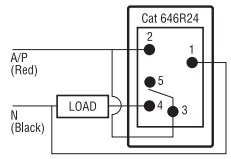

Wiring Diagrams

691RCD (10 and 30mA)

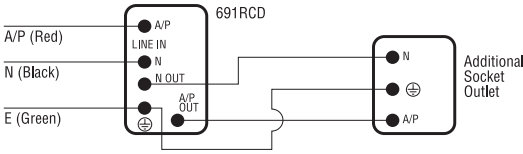

695RCD (10 and 30mA)

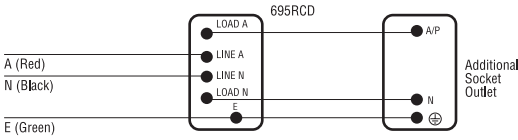

896RCD, 696RCD and 596RCD (10 and 30mA)

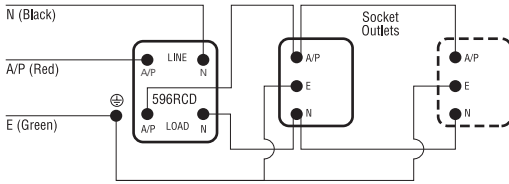

882M10N Intermediate Switch Module

Any number of intermediate switches can be wired between the 2 way switches

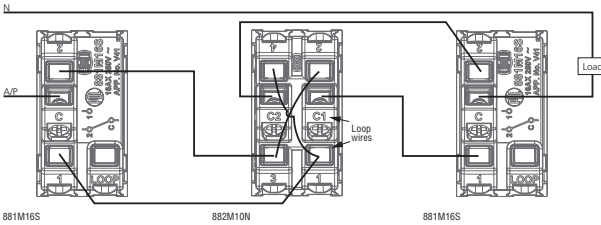

Sensor Auto By-Pass (Permanently On)

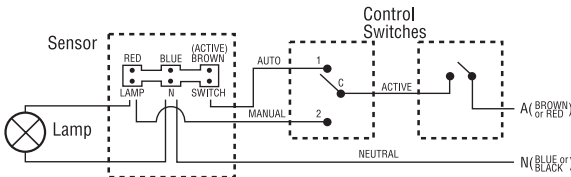

Wiring Diagrams

750WP & 753 2 Wire Infracan®

1a) Automatic Operation



1b) Automatic with manual override ON or OFF

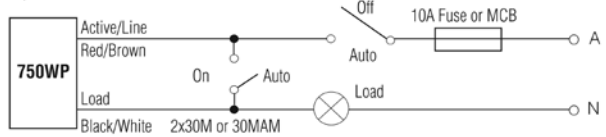

1c) ON, OFF or AUTOMATIC Operation using a 3 position switch

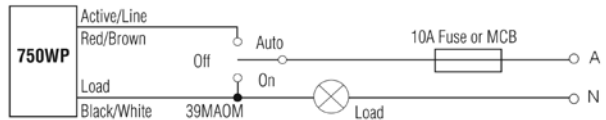

Note:

- When switching to Auto for any of the above configurations the Infracan will turn on. Allow 30 seconds plus time-on period for the sensor to stabilise for normal operation. Wiring diagram 1(a), without override switches is preferred as there is no settling period.
- More than one 750WP CANNOT be connected in parallel to a common load. If parallel connection of multiple devices to control a common load is required, use Cat. No. 750WPR.

Wiring Diagrams

750WPR & 753R 3 Wire Infracan®

2a) Automatic Operation

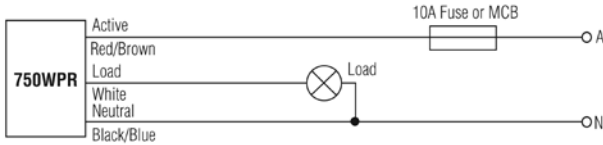

2b) Automatic with manual override ON or OFF

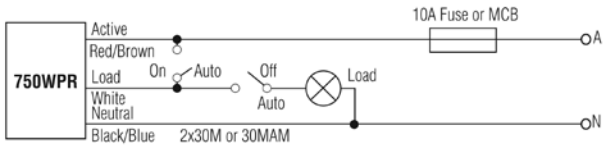

2c) ON, OFF or AUTOMATIC Operation using a 3 position switch

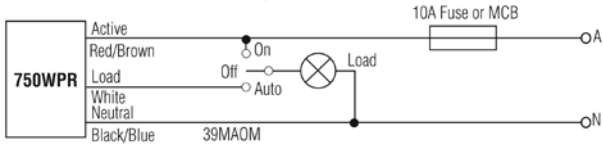

Wiring Diagrams

Option 1 – RCBO

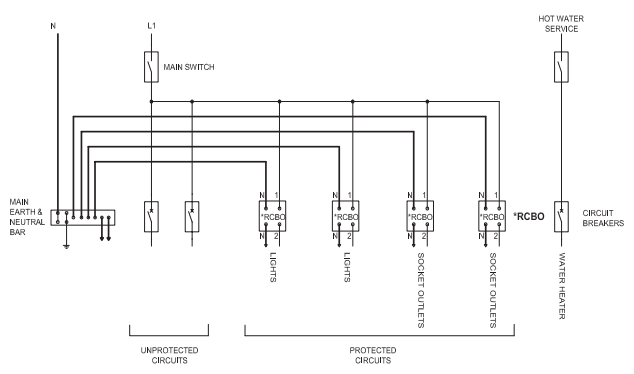

Option 2 – RCCB

Minimum of two RCD devices in domestic installations having more than one final subcircuit, and that each RCD shall supply a maximum of three final subcircuits.

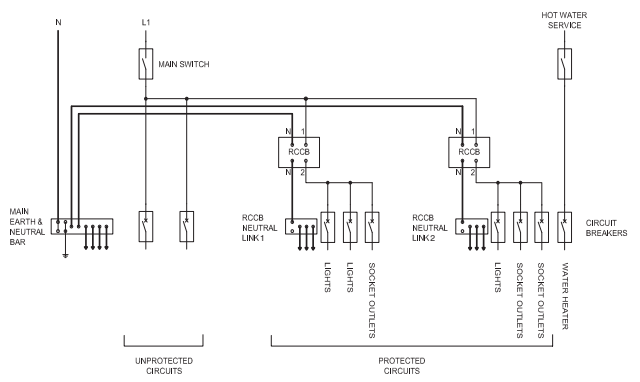

AFDD

Example of Arc Fault Detection Device Note - AFDD product shown includes MCB protection in one single unit.

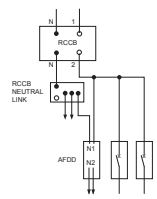

Wiring Diagrams

56SW320F/R

Single Phase Reversing

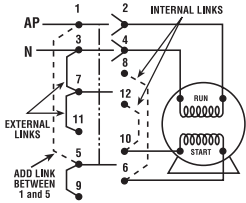

Three Phase Reversing

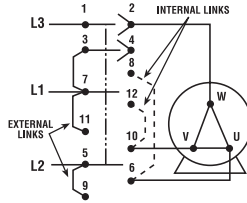

56SW320C/O and 56SW332C/O

3 Pole Changeover

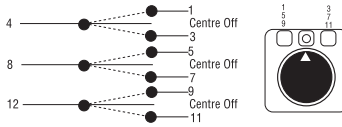

Wiring Diagrams

Dali Simple – simple automation designed for simple commercial applications and base builds

Installation requirements:

- Windows or equivalent PC
- Free DaliSimple Wizard software
- USB to DALI controller cable (DCCABKIT6)

Open Plan Office Single Line Diagram

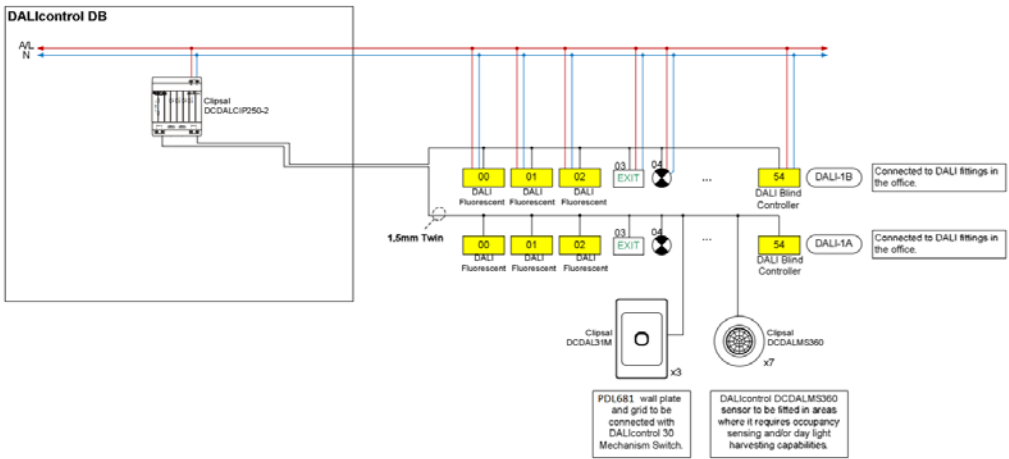

Notes:

- 5 Core 1.5mm TPS is often used to minimize installation time (2x DALI signal line + P + N + E)
- DALI switch mechanisms and sensors are powered from the DALI signal line

Alphanumeric Index

Cat No	Page
100MPIR	124
10M	108
137MB-VW	101
140C	100
141C	100
1439/20	109
1439/4P	109
1439S	109
144M	100
144P	100
145V	100
146S	100
149	100
151	102
152	102
15335	135
154	105
155NAR	105
155P	105
155VNAR	105
157P	105
1588M	59
193/1	103
193/15/1	103
193/15/2	103
193/2	103
194	103
1CB100	186
2000	219
2000/2	219
2000/3	219
2000/4	219
2000H2	219
2000H3	219
201	102
2015	220
2015/15	220

Cat No	Page
2015/20	220
2015V	220
2015XS	220
202	102
2025	220
2025/15	220
2025V	220
2025XA	220
2031VAUSMT	219
2031VH	219
2031VX	219
2032VAUSM	219
2032VH	219
2033VAUSM	219
2033VH	219
2034VH	219
2035VH	219
2036VH	219
2154H2	81
2157/2	221
2157H2	81
220/16	202
220/20	202
220/25	202
220S20	202
220S25	202
220S32	202
220S40	202
220S50	202
222/2M-GY	114
230DRAQTPL	130
238	105
240/20/1	199
240/20/2	199
240/20/2A	199
240/20/3	199
240/20/4	199

Alphanumeric Index

Cat No	Page
240/25/1	199
240/25/2	199
240/25/2A	199
240/25/3	199
240/25/4	199
240L	199
242/16	202
242/20	202
242/25	202
242/32	202
242/40	202
242/50	202
243/16	202
243/20	202
243/25	202
243/32	202
243/40	202
244/16	201
244/20	201
244/25	201
244/32	201
244/40	201
244/50	201
245/16	203
245/20	203
245/25	203
246/16	201
246/20	201
246/25	201
246/32	201
246/40	201
246/50	201
247/16	203
247/20	203
247/25	203
247/32	203
247/40	203

Cat No	Page
247/50	203
247/20	201
247/25	201
247L20	203
247L25	203
247L32	203
247L40	203
247LH20	203
247LH25	203
247LH32	203
247LH40	203
249/12	199
251/16	204
251/20	204
251/25	204
251/32	204
251/40	204
252/32/1	200
252/32/2	200
252/32/2A	200
252/32/3	200
252/32/4	200
252/40/1	200
252/40/2	200
252/40/2A	200
252/40/3	200
252/40/4	200
252/50/1	200
252/50/2	200
252/50/3	200
252/50/4	200
2530	122
258/16	204
258/20	204
258/25	204
258/32	204
258/40	204

Alphanumeric Index

Cat No	Page	Cat No	Page
259/16	206	264/2SM	205
259/20	206	264/3M	205
259/25	206	264/3SM	205
259/32	206	264/4M	205
259/40	206	264/4SM	205
259/50	206	264/5M	205
26	120	265/1	200
260/16	206	265/3	200
260/20	206	265/4	200
260/25	206	265/5	200
260/32	206	279AC16	208
260/40	206	279AC20	208
261/16	207	279AC25	208
261/20	207	279C16	208
261/25	207	279C20	208
261/32	207	279C25	208
261/40	207	279C32	208
261/50	207	279C40	208
261E20	207	279C50	208
261E25	207	280/16	207
261S20	207	280/20	207
261S25	207	280/25	207
262/20	205	280/32	207
262/25	205	280/40	207
262/32	205	281/16	206
262/40	205	281/20	206
262/50	205	281/25	206
263/16	205	281/32	206
263/20	205	281/40	206
263/20C	208	281/50	206
263/25	205	281F16	206
263/32	205	281F20	206
263/40	205	281F25	206
263/50	205	281F32	206
264/1M	205	281F40	206
264/1SM	205	28L	120
264/2M	205	29L	120

Alphanumeric Index

Cat No	Page
2D4P6IPV3B-BU	145
30/2NM	83
300ALED-W	7
300DMB-VW	101
300KBC-AN	8
300KBC-CY	8
300KBC-VW	8
300KBC-VW	20
300KBC-WY	8
300PBC-CY	8
300PBC-VW	8
300PBC-WY	8
300SMB-VW	101
300USB2C-AN	9
300USB2C-CY	9
300USB2C-VW	9
300USB2C-WY	9
300USB2CAC-AG	20
300USBC-AG	20
300USBC-AN	9
300USBC-CY	9
300USBC-VW	9, 20
300USBC-WY	9
300USBC2-AG	20
300USBC2-VW	20
3040	112
3041	112
3042	112
306-AN	14
306-CY	14
306-VW	14
30A	120
30B	120
30BCBM	85
30BCRM	85
30FAVB	85
30FAVRGB	85

Cat No	Page
30FAVRWO	85
30FAVRWY	85
30FAVY	85
30FFPFMS	85
30HDMIS-WE	85
30M	83
30M35	83
30MBPR	83
30MD	83
30MD2	83
30MD20	83
30MI	83
30N	84
30N12	84
30NPA	84
30P	86
30PB	83
30PBBP	83
30PBBPL	83
30PBI	83
30PBL	83
30PFM	85
30RJ45SM6AF	144
30RJ45SMA6C	86
30RJ45SMA6C-WE	144
30SPK/2	85
30TKM	83
30TV75M	85
30USBCM	85
30USM	83
310ML-AM	37
310ML-GN	37
310ML-RD	37
310ML24-GN	37
310ML24-RD	37
310MLPA-AM	37
3157/4PRM	100

Alphanumeric Index

Cat No	Page
3157/4PRM	101
315HDMI-TN	10, 38
315MBBR-TN	10
315MF-TN	10, 38
317M2-TN	10, 38
319MAC-TN	39
319MD-TN	10, 38
327CEP-VW	10
328MF-TN	10, 38
328PF-VW	10, 38
32E500FM	84
32ELEDM	84
331GC-VW	9
332GC-VW	9
333GC-VW	9
334GC-VW	9
335GC-VW	9
340MRB-TN	10, 38
342USB-VW	9
342USB-VW	38
342USB2-VW	9, 38
342USB2AC-VW	9
343HSC-AN	10
343HSC-CY	10
343HSC-VW	10
343HSC-WY	10
343USBG	10, 21, 27
347VH-VW	11, 21, 27
347VHC-AN	11
347VHC-CY	11
347VHC-VW	11
347VHC-WY	11
350C-AN	11
350C-CY	11
350C-VW	11
350C-WY	11
350G	11

Cat No	Page
351-VW	10
352MPIR	124
352MPIR-TN	9, 38
354PBDMBTW-VW	8
354PBDMUN-VW	8
354RDMLED-VW	8
354RDMUN-VW	8
356PB10MBTW-VW	8, 38
356PBSM-VW	8, 38
356PBSS-VW	8, 38
356PBSSL-VW	8
361C-AN	11
361C-CY	11
361C-VW	11
361C-WY	11
361G	11
362C-AN	11
362C-CY	11
362C-VW	11
362C-WY	11
362G	11
378M10	37
378M10L	7
380AR32-AN	7
380AR32-CY	7
380AR32-VW	7
380AR32-WY	7
380M20DP	7
380M32-VW	7
381-VW	5
381AFAN-VW	6
381AFRIDGE-VW	6
381AHEAT-VW	6
381AHOOD-VW	6
381ALIGHT-VW	6
381ALR-AN	8
381ALR-CY	8

Alphanumeric Index

Cat No	Page
381ALR-VW	8
381ALR-WY	8
381AMICROWVE-VW	6
381AOUTSIDE-VW	6
381AR-AN	6
381AR-CY	6
381AR-VW	6
381AR-WY	
381ASENSOR-VW	6
381AWASTE-VW	6
381C-AN	5
381C-CY	5
381C-VW	5
381C-WY	5
381G	5
381GM10	19, 25
381M10	6
381M10PML-VW	7
381M20	6
381PAM-VW	6
381PDY-VW	6
381PHOB-VW	7
381PHW-VW	6
381POVEN-VW	7
381PRANGE-VW	7
381VWP-VW	11
382-VW	5
382C-AN	5
382C-CY	5
382C-VW	5
382C-WY	5
382G	5
382GM10	19, 25
382VWP-VW	11
383-VW	5
383C-AN	5
383C-CY	5

Cat No	Page
383C-VW	5
383C-WY	5
383G	5
383GM10	19, 25
383VWP-VW	11
384-VW	5
384C-AN	5
384C-CY	5
384C-VW	5
384G	5
384GM10	19, 25
384VWP-VW	
385C-AN	6
385C-CY	6
385C-VW	6
385C-WY	6
385G	6, 19, 25, 25
386C-AN	6
386C-CY	6
386C-VW	6
386C-WY	6
386G	6, 19
387A3T-AG	20
387A3T-AN	7
387A3T-CY	7
387A3T-VW	7, 20
387A3T-WY	7
387A4R	7
387ALBLKIT-VW	7
387M3T-VW	7
387M4R	7
38A	86
38HD	86
38TB	86
391-VW	12
391C-AN	12
391C-CY	12

Alphanumeric Index

Cat No	Page
391C-VW	12
391C-WY	12
391G	12
391RCD30-VW	15
391RCD30C-VW	15
392-VW	12
392C-AN	12
392C-CY	12
392C-VW	12
392C-WY	12
392G	28
392USB-VW	15
392X-VW	12
392XC-AN	12
392XC-CY	12
392XC-VW	12
392XUAG	12
394-VW	13
394/15-VW	13
394/15C-AN	13
394/15C-CY	13
394/15C-VW	13
394/15C-WY	13
394/15G	13
394/20-VW	13
394/20C-AN	13
394/20C-CY	13
394/20C-VW	13
394/20C-WY	13
394/20G	13
394C-AN	13
394C-CY	13
394C-VW	13
394C-WY	13
394G	13, 29
394XC-AN	13
394XC-CY	13

Cat No	Page
394XC-VW	13
394XUA	29
394XUA-VW	13
394XUAG	13
395-VW	14
395/15-VW	14
395/15C-AN	14
395/15C-CY	14
395/15C-VW	14
395/15C-WY	14
395/15G	14
395C-AN	14
395C-CY	14
395C-VW	14
395C-WY	14
395G	14, 29
395H4-VW	15
395H4C-AN	15
395H4C-CY	15
395H4C-VW	15
395H4C-WY	15
395H4MB-VW	101
395H4XXC-AN	15
395H4XXC-CY	15
395H4XXC-VW	15
395H4XXC-WY	15
395H4XXUA-VW	15
395H4XXUAG	15, 29
395RCD30-VW	15
395USB-VW	15
395X-VW	14
395XC-AN	14
395XC-CY	14
395XC-VW	14
395XC-WY	14
395XUAG	14, 29
4000VH1	81

Alphanumeric Index

Cat No	Page
4015	70, 74
4015L	70, 74
4025	70, 74
4025H2	70, 74
4025X	70, 74
4025XA	70, 74
4031VH	69, 73
4032VH	69, 73
4033VH	69, 73
4034VH	69, 73
4036VH	69, 73
4060CSFM-CC	80
4060VX	68, 72
4061	69, 72
4061/45	69, 73
4061AL	69, 72
4061D32	69
4061E2PUDM-TR	65, 80
4061PBL	68, 72
4061VF3CSF	69, 73
4061VH	68, 72
4062	69, 72
4062AL	72
4062E45UDM-TR	65, 69, 73, 80
4062EDIM-KB-CC	73, 80
4062PBHL	68
4062PBL	68, 72
4062VH	68, 72
4063PBL	68, 72
4063VH	68, 72
4064VH	68, 72
4065VH	68, 72
4066VH	72
408/3	108
408/4	108
409/3	108
410	107

Cat No	Page
413QC	107
418S	109
438	107
438S15	107
438S15HD	107
438XHD	107
439/4	109
439SL	109
439SXHD	109
44	120
449C-WE	91
449CSD-WE	91
44A	120
493	137
493BTL	137
493BTLI	137
493L	137
493SB	137
4DBE	130
4FCC15SK	130
4PSO10	130
4RCBE210/10	218
4RCBE216/10	218
4RCBE220/10	218
4RCBE232/10	218
4SSO15D	130
4SSO15D15	130
500TT	61
501	122
501ES	122
501J/50	102
501SK	121
5031NMML	151
5031NMS	151
5031PEWP-GY	153
5031RDTSL-WE	153
5041NMML	151

Alphanumeric Index

Cat No	Page
5041NMS	151
5080CTL2	151
5082NL	151
5084NL	151
5085EDLB-EB	151
5085EDLB-HB	151
5085EDLB-OM	151
5085EDLB-PW	151
5085EDLB-SS	151
5085EDLW-OM	151
5085EDLW-PW	151
5086NL	151
5100DTSF	153
5100DTSP	153
5102RVF	154
5104DTSI	153
51SS	103
526KC	43
544	102
544J	102
5500CN2	152
5500DMX	152
5500NAC	152
5500NB	152
5500PACA	152
5500PC	152
5500PCU	152
5500PS	152
5500SHAC	152
5501FRE	154
554/4	106
554J4	106
564/00J	105
564/0J	105
564/1J	105
564/2J	105
564PC1	106

Cat No	Page
564PC2	106
564PC3	106
564PC4	106
567/13	106
567/16	106
567/19	106
567/20	106
567/22	106
567/25.5	106
567/32	106
567/9.5	106
56AI310	182
56AI315	182
56AI320	182
56AI416	183
56AI420	183
56AI432	183
56AI440	183
56AI450	183
56AI516	183
56AI520	183
56AI532	183
56AI540	183
56AI550	183
56AM25	173
56BRIDGE	185, 187
56C310RCD-30	226
56C310RCD30	181
56C316RCD-30	226
56C316RCD30	111, 181
56C320RCD-30	226
56C320RCD30	181
56CB13	186, 129
56CB4	111, 186, 226, 129
56CR310	183
56CR315	183
56CR320	183

Alphanumeric Index

Cat No	Page
56CR416	184
56CR420	184
56CR432	184
56CR440	184
56CR450	184
56CR516	184
56CR520	184
56CR532	184
56CR540	184
56CR550	184
56CSC310	183
56CSC315	183
56CV310	180
56CV315	180
56CV316/240	111
56CV316240	181
56CV320	180
56CV332	180
56CV416	180
56CV420	180
56CV432	180
56CV440	180
56CV450	180
56CV516	180
56CV520	180
56CV532	180
56CV540	180
56CV550	180
56CV716	180
56D	187
56DIVIDER	185, 187
56DL2	186
56DL4	186
56DL6	186
56DOL12LO	190
56DOL12LOB	190
56DOL16LO	190

Cat No	Page
56DOL16LOB	190
56DOL9LO	190
56DOL9LOB	190
56E/2020	185
56E1	185
56E12525	185
56E16	185
56E1S	185
56E2	185
56E2/25/25	185
56E2/40	185
56E2FOOD	185
56E2S	185
56E2V	185
56E3	185
56E3/25/25	185
56E4	185
56E4VH	185
56E4VHUN	185
56E6	185
56E8	185
56E9	185
56ED2/40	185
56FA1	187
56FA2	187
56FA3	187
56FA4	187
56G1	187
56G2	187
56HPG1	188
56HPG21	188
56HPG22	188
56L1	186
56L1221	187
56L1222	187
56L2	186
56L3	186

Alphanumeric Index

Cat No	Page
56L4	186
56LEDK1	177, 181
56LEDK3	177
56MF	187
56MO3001	186
56MO3002	186
56MO5001	186
56P310	171
56P310R	171
56P315	171
56P320	171
56P320F	171
56P332	171
56P416	171
56P416K	171
56P420	171
56P432	171
56P440	171
56P450	171
56P516	171
56P520	171
56P532	171
56P540	171
56P550	171
56P616	171
56P716	171
56P720	171
56PA320	171
56PA332	171
56PA416	171
56PA416K	171
56PA420	171
56PA432	171
56PA440	171
56PA450	171
56PA516	171
56PA520	171

Cat No	Page
56PA532	171
56PA540	171
56PA550	171
56PA616	171
56PA716	171
56PB1GN	175
56PB1RD	175
56PBT10	181
56PC	173
56PE225	185
56PLUG20	187
56PLUG25	187
56POK	173
56RCD20-30	226
56RCD2030	181
56SHL	173
56SHM	173
56SO310	173
56SO310/2	173
56SO310A	173
56SO310R	173
56SO315	173
56SO315A	173
56SO316-CEE	189
56SO316/240	111
56SO316110	174
56SO316240	174
56SO320	173
56SO320F	173
56SO332-CEE	189
56SO416	174
56SO416-CEE	189
56SO416K	174
56SO420	174
56SO432	174
56SO432-CEE	189
56SO440	174

Alphanumeric Index

Cat No	Page
56SO450	174
56SO516	174
56SO516-CEE	189
56SO520	174
56SO532	174
56SO532-CEE	173
56SO540	174
56SO550	174
56SO616	174
56SO716	174
56SPO310	184
56SS10	121, 176
56SS10WE	121, 176
56SW01	177
56SW110	175
56SW1102	175
56SW1102I	175
56SW116	175
56SW120	175
56SW120CO	179
56SW132	175
56SW150	175
56SW210	175
56SW216	175
56SW220	176
56SW232	176
56SW250	176
56SW310	176
56SW316	176
56SW320	176
56SW320CO	179
56SW320FR	179
56SW320KG	179
56SW320KGAUX	179
56SW332	176
56SW332CO	179
56SW332KG	179

Cat No	Page
56SW332KGAUX	179
56SW340	176
56SW340KG	179
56SW350	176
56SW3502	176
56SW3632	176
56SW363KG	179
56SW420/KG	179
56SW4202KG	176
56SW432/KG	179
56SW620/KG	179
56SWB3322KG	177
56SWB3402KG	177
56SWB3632KG	177
56SWB4202KG	177
56SWB4322KG	177
56TC24HB	181
56TC7DB	181
56XDL1	186
5750WPL-GY	153
5751L-WE	153
5753L	153
5753PEIRL	153
5754ODPE	153
5754ODPEIR	153
5754PE	153
576	103
593/15PP	105
600B	60
600BID	60
600RM	58
600SM	59
609M	62
60PB	64
60PB	68
60PB	72
60PBBPL	64, 68, 72, 80

Alphanumeric Index

Cat No	Page
60PBC-3A	81
60PBC-CC	81
60PBI	64, 68, 72, 80
60PBL	64, 68, 72
60R16	70, 74, 80
60R32	70, 74, 80
60R32COOK	70, 74, 80
60RSM3	68, 80
60ZPBC	65
610ML12	60
610ML24	60
610MN	60
610TML24	60
615HDMI	62
615MBB	62
615MF	62
615MFSKY	62
615MFTV	62
615MRB	62
616M	62
617BT2	51
617M2	61
619MAC	61
619MALC	61
619MD	61
619MDL	61
619MKC	61
619MKLC	61
619MM	61
624T	45
624TM	59
625FM	59
626N	43
626VC2	43
628	51
628F	51
628M	62

Cat No	Page
628MF	62
628MFI	62
628MFO	62
628MFS	62
628MFV	62
629	120
629M	62
632	45
634L	45
634LM	59
640MFWH	62
640MFYL	62
640RC	101
640SC	101
641	50
641/15	50
641C	49
641P	52
644	50
644/15	50
644P	52
646E7	
646R24	45
646R7	45
647	43
648TM	58
650BVH	42
650VH	42
651	44
651M2	59
651VWP	44
654	45
654M	59
654PBM	59
661VH	42
662VH	42
663VH	42

Alphanumeric Index

Cat No	Page
664VH	42
666TMB24	59, 60
666TML24	60
673MM	58, 60
678M16	56
680	43
680M20N	56
680M32	56
680M32AC	56
680M32H	56
680M32IO	56
680M32O	56
680M32R	56
680TMNPB	60
680TMPB	60
681	42
681HID	42
681HWP	44
681M16HF	57
681M16HFAL	57
681M16HFCL	57
681M16HFF	57
681M16HFMW	57
681M16HFS	57
681M16PS	58
681M20	56
681M20AC	57
681M20AM	57
681M20AP	57
681M20B	56
681M20D	57
681M20DR	57
681M20DW	57
681M20DY	57
681M20F	57
681M20FG	57
681M20FR	57

Cat No	Page
681M20G	57
681M20GN	57
681M20H	57
681M20HA	57
681M20HD	57
681M20HLF	57
681M20HWS	57, 58
681M20I/O	57
681M20KT	57
681M20L	57
681M20LO	57
681M20MR	57
681M20MW	57
681M20O	57
681M20P	56
681M20PB	56
681M20PL	57
681M20PU	57
681M20R	56
681M20S	57
681M20SE	57
681M20ST	57
681M20TL	57
681M20TV	57
681M20WH	57
681M20WT	57
681MT16	56
681VH	42
681VID	42
681VWP	44
682	42
682HID	42
682HWP	44
682VH	42
682VID	42
682VWP	44
682VWPD	44

Alphanumeric Index

Cat No	Page
683	42
683HID	42
683HWP	44
683HWPD	44
683VH	42
683VWP	44
683VWPD	44
684HWP	44
684HWPD	44
684VH	42
684VID	42
684VWP	44
684VWPD	44
685VH	42
686VH	42
687M10	56
687M3	58
687M3A/M	58
687M3/II	58
687M4	58
687M4F	58
688VH	42
689VH	42
691	50
691/15	51
691C	48
691MBBZ	48
691MPB	48
691MSS	48
691R	51
691RCD-10	53, 225
691RCD-30	53, 225
691RCDC	48
691X	50
691XC	48
691XMBBZ	48
691XMPB	48

Cat No	Page
691XMSS	48
692	50
692/15	51
692C	48
692ID	52
692MBBZ	48
692MPB	48
692MSS	48
692N	50
692P	52
692R	51
692X	50
692XC	48
692XMBBZ	48
692XMPB	48
692XMSS	48
693/2	50
694	50
694/15	51
694C	48
694MBBZ	48
694MPB	48
694MSS	48
694X	50
694XC	48
694XMBBZ	48
694XMPB	48
694XMSS	48
694XX	50
694XXC	48
694XXMBBZ	48
694XXMPB	48
694XXMSS	48
695	50
695/15	51
695C	48
695MBBZ	48

Alphanumeric Index

Cat No	Page
695MPB	48
695MSS	48
695N	50
695P	52
695R	51
695RCD-10	53, 225
695RCD-30	53, 225
695USB	50
695X	50
695XC	48
695XMBBZ	48
695XMPB	48
695XMSS	48
696RCD-10	53, 225
696RCD-30	53, 225
698	51
698/15	51
698MBBZ	48
698MPB	48
698MSS	48
698R	52
699	51
699C	48
699TB	51
699TBC	48
699TBMPB	48
699TBMSS	48
699TBR	52
699TMBBZ	48
7005A	140
7006A	140
7100WP	140
7105A	140
7106A	140
7107A	140
7108A	140
750MBA	124

Cat No	Page
750WP	123
751	124
751MB	124
751R	124
753	124
755PSMA4	124
755RB	124
755RFB2	124
755RLPSMA4	124
800FB2H	91
800FB2V	91, 100
800G	89
800G2H	89
800G2V	89
800GV	89
800L240MBL	98
800L240SBL	98
800MA	98
800MAC	98
800N240	98
800PS2HBK	91
800PS2HBL	91
800PS2HCC	91
800PS2HCH	91
800PS2HCM	91
800PS2HGM	91
800PS2HPT	91
800PS2HRD	91
800PS2HWH	91
800PS2VBK	90
800PS2VBL	90
800PS2VCC	90
800PS2VCH	90
800PS2VCM	90
800PS2VGM	90
800PS2VPT	90
800PS2VWH	90

Alphanumeric Index

Cat No	Page
800PSBK	90
800PSBL	90
800PSCC	90
800PSCH	90
800PSCM	90
800PSGM	90
800PSPT	90
800PSRD	90
800PSVBK	89
800PSVBL	89
800PSVCC	89
800PSVCH	89
800PSVCM	89
800PSVGM	89
800PSVPT	89
800PSVRD	89
800PSVWH	89
800PSWH	90
815HDMI1	97
815HDMI2	97
815MB	97
815MF2	97
815MKC1	96
815MKC2	96
815MST35	97
815MVGA	97
815USB2	97
824T	88
825F	88
834L	88
840MFRGB	97
840MFRWY	97
847/1	112
847/2	112
847/3	112
847/4	112
848	112

Cat No	Page
851	88
854	88
854PB	88
860BM	98
860M16	93
861M16	93
880BM	98
880BML	98
880MT1SPB	93
880MT2SPB	93
880TPB1	93
880TPB2	93
881	88
881M16M	93
881M16S	93
881M16SP	93
881M16V	93
881M32SN	95
881M32SNBL	95
881M32SNH	95
881M32SNHBL	95
881M32SNR	95
881M32SNRBL	95
881V	88
882	88
882M10N	93
882M10NBL	93
882V	88
883	88
883V	88
891A	88
891MA	95
892A	88
892ABL	88
892MA	95
892MA/15	96
892MABL	95

Alphanumeric Index

Cat No	Page
894	88
894BL	88
894M	95
894MA	95
894MBL	95
894USB	88
895A	88
895ABL	88
895MA	95
895MA/15	96
895MABL	95
9	86
900/100/100	211
900/100/100P	212
900/100/100T	212
900/100/50E	212
900/100/50EE	211
900/100/50EI	211
900/100/50P	212
900/100/50T	212
900/100/75	211
900/100/75E	212
900/100/75EE	211
900/100/75EI	211
900/100/75P	212
900/100/75T	212
900/100100EI	211
900/16/10	209
900/16/16	209
900/16/16C	209
900/16/16E	210
900/16/16EE	209
900/16/16EI	209
900/16/16P	210
900/16/16T	210
900/25/16	209
900/25/16C	209

Cat No	Page
900/25/16CA	210
900/25/16E	210
900/25/16EE	209
900/25/16EI	209
900/25/16P	210
900/25/16T	210
900/25/16TR	210
900/25/16TS	210
900/25/25	209
900/25A25	210
900/40/16	209
900/40/25	209
900/40/25/2	209
900/40/25C	209
900/40/25E	210
900/40/25EI	209
900/40/25P	210
900/40A25	210
900/50/50	211
900/50/50E	212
900/50/50EE	211
900/50/50EI	211
900/50/50P	212
900/50/50T	212
900/75/50	211
900/75/50E	212
900/75/50EE	211
900/75/50EI	211
900/75/50P	212
900/75/50T	212
900/75/75	211
900/75/75E	212
900/75/75EE	211
900/75/75EI	211
900/75/75P	212
900/75/75T	212
900AT12	210

Alphanumeric Index

Cat No	Page
900AT18	210
900CC	212
900D100S	212
900D50S	212
900D75S	212
900RMB	
900SKMB	210
900SPBP	210
900SPMB	210
901	104
901/15	104
9016TCM	198
9020CMS	198
9020CMS20	198
9020TCM	198
9020TCM10	198
9020TCM20	198
9025CMS	198
9025CMS20	198
9025TCM	198
9025TCM10	198
9025TCM20	198
903	104
9032TCM	198
9032TCM10	198
9040TCM	198
9040TCM10	198
905	104
905/15	104
9050TCM	198
905LR	104
905R	104
925R	104
925R15	104
927	103, 104
927P	104
93/5	122

Cat No	Page
940	104
951	227
952	227
955	227
955RW	227
976	103
976P	103
A9C20732	135
A9C30811	135
A9C30812	135
A9M17065	135
A9MEM2000	135
A9MEM2010	135
A9S66191	134
A9S66291	134
A9S66391	134
A9T26606	135
A9T26610	135
A9T26616	135
A9T26620	135
A9X21094	133
A9XPC612	133
A9XPC624	133
A9XPE110	133
A9XPH112	133
A9XPH124	133
A9XPH612	133
A9XPH624	133
A9XPT620	133
A9XPT920	133
A9Z51216	132, 159, 228
A9Z51225	132, 159, 228
A9Z51240	132, 159, 228
A9Z51440	132, 159, 228
ABL8MEM24003	152
ACT4P6UPEJ3RBK	145
ACTFM1UF2LC6PMM	146

Alphanumeric Index

Cat No	Page
ACTMP1U	146
ACTMPBP	146
ACTPP6U24NSS	143
ACTRJSMTG6ANSS	144
ACTRJSMTG6ANSSP	144
ACTTG4P6AUCM3RBU	145
B30GFZ	86
B31A	76
B32A	76
B33A	76
BALS098	110
BALS1217	110
BALS1S055	110
BALS211	110, 189
BALS21238	110, 189
BALS21240	189
BALS21241	189
BALS21349	189
BALS21351	189
BALS21485	189
BALS231	110, 189
BALS2638	110
BALS311	189
BALS31240	110, 189
BALS31244	189
BB31A	76
BB32A	76
BB33A	76
BBSL15A	78
BBSL15XA	78
BBSL25A	78
BBSL31VA	76
BBSL31VH	77
BBSL32VA	76
BBSL32VH	77
BBSL33VA	76
BBSL33VH	77

Cat No	Page
BBSL34VH	77
BBSL35VH	77
BBSL36VH	77
BP365N	112
BPT2	112
BS5000CTL2	151
BSL15A	78
BSL15XA	78
BSL25A	78
BSL25XA	78
BSL31VA	76
BSL31VH	77
BSL32VA	76
BSL32VH	77
BSL33VA	76
BSL33VH	77
BSL34VH	77
BSL35VH	77
BSL36VH	77
CCT551011	125
CE200	140
CE250	140
CLITPBHS2	123
CLITPDL1C2	123
CLITPDL1T2CBC	123
CLITPDL2K3	123
CLITPDL2K4	123
CLITPFLS10LED	123
CLITPFLS20LED	123
CLITPFLS20SENLED	123
CLITPFLS50LED	123
CPLRJ24USPPAN	143
DBF10	129
DBF15	129
DBF15/19	130
DBF15/23	130
DBF15ASSY	130

Alphanumeric Index

Cat No	Page
DBF30	129
DBF30ASSY	130
DBF30BPDOM	129
DBF45	129
DBF45ASSY	130
DBF45ASSYNT	130
DBF60	129
DBF60ASSY	130
DBF60ASSYNT	130
DBFN4	130
DBFNE9	130
DBFPMK	130
DBS15	129
DBS30	129
DBS45	129
DBS60	129
DCDAL31M2PB	155
DCDAL31MOD	155
DCDAL31MPE	155
DCDAL31SPB	155
DCDAL31SPBUD	155
DCDAL31SRKUD	155
DCDALCIP250-2	155
DCDALMS360	155
DCK12458	134
DCK12461	134
DCK12464	134
DOM11375	134
DOM11376	134
DOM11377	111, 134
DOM11378	134
DOM11379	134
DOM11380	134
DOM11381	134
DOM12529	134, 228
DOM12530	134, 228
DOM12531	134, 228

Cat No	Page
DOM12532	134, 228
DOM12533	134, 228
DOM16695	134, 228
DOM16696	134, 228
DOM19802	135, 228
DOM19803	111, 135, 228
DOM19804	135, 228
DOM19805	135, 228
DOM19806	135, 228
DOM19807	135
E01CNN10	218
E01CNN16	218
E01CNN20	218
E01CNN32	218
E03/10/10	218
E300KBC-AG	20
E300PBC-AG	20
E300PBC-AW	20
E343C-AG	21
E343C-AW	21
E347VHC-AG	21
E380AR32-AG	20
E380AR32-AW	20
E381AR-AG	20
E381AR-AW	20
E381C-AG	19
E381C-AW	19
E382C-AG	19
E382C-AW	19
E383C-AG	19
E383C-AW	19
E384C-AG	19
E384C-AW	19
E385C-AG	19
E385C-AW	19
E386C-AG	19
E392C-AG	22

Alphanumeric Index

Cat No	Page
E392C-AW	22
E392XC-AG	22
E392XC-AW	22
E394C-AG	22
E394C-AW	22
E394XC-AG	22
E394XC-AW	22
E395C-AG	22
E395C-AW	22
E395H4C-AG	22
E395H4C-AW	22
E395H4XXC-AG	22
E395XC-AG	22
E395XC-AW	22
EVH2S11P04K	159
EVH2S11P0CK	159
EVH2S22P0CK	159
EVH2S7P04K	159
EVH2S7P0AK	159
EVH2S7P0CK	159
F251/20	204
F251/25	204
F251/32	204
F251/40	204
F251/50	204
F30Z1	86
F30Z1.5	86
F30Z2	86
KITWALLBOX7	132, 159
L4T35R	112
L5108RELV	154
L5501RBCP	154
L5501RFCP	154
L5504D2A	154
L5504D2AP	154
L5504D2U	154
L5504D2UP	154

Cat No	Page
L5504RVF	154
L5504RVF20	154
L5504RVF20P	154
L5504RVFC	154
L5504RVFCP	154
L5504RVFP	154
L5508D1A	154
L5508D1AP	154
L5508DSI	154
L5508DSIP	154
L5508RVF	154
L5508RVFP	154
L5512RVF	154
L5512RVFP	154
LC1D09II	190
LC1D12II	190
LRD05	190
LRD06	190
LRD07	190
LRD08	190
LRD10	190
LRD12	190
LRD14	190
LRD16	190
LRD21	190
LXD1II	190
MG15	130
MIP0106S	129
MIP0108S	129
MIP0112S	129
ML2000	217
ML2015	216
ML2015/15C	216
ML2015/15I	216
ML2015/15VI	216
ML2015C	216
ML2015I	216

Alphanumeric Index

Cat No	Page	Cat No	Page
ML2015V	216	NSYTBP292412	195
ML2015VI	216	NSYTBP292412H	195
ML2025	216	NSYTBP292416H	195
ML2025I	216	NSYTBP29248	195
ML2025RCD10	217	NSYTBP342912	195
ML2025RCD10C	217	NSYTBP342916H	195
ML2025V	216	NSYTBP775	195
ML2025VI	216	NSYTBP885	195
ML2031RCD10	216	NSYTBS111113H	194
ML2031VR01	217	NSYTBS11116	194
ML2032VR02	217	NSYTBS1176	194
ML2164	217	NSYTBS1179H	194
ML2164/3W	217	NSYTBS1397	194
ML2164E35	217	NSYTBS1397T	194
MOUNTING CENTRES		NSYTBS16128	194
N01	218	NSYTBS16128T	194
NSYAEDH20TB	196	NSYTBS191210H	194
NSYAEFTB	196	NSYTBS19128	194
NSYAMPA1916TB	196	NSYTBS19128T	194
NSYAMPA2419TB	196	NSYTBS191610H	194
NSYAMPA2924TB	196	NSYTBS191610HT	194
NSYAMPA3429TB	196	NSYTBS19168	194
NSYTBP11116	195	NSYTBS19168T	194
NSYTBP1176	195	NSYTBS241910H	194
NSYTBP1397	195	NSYTBS241910HT	194
NSYTBP1397T	195	NSYTBS241912H	194
NSYTBP16128	195	NSYTBS24198	194
NSYTBP16128T	195	NSYTBS292412	194
NSYTBP191210H	195	NSYTBS292412H	194
NSYTBP19128	195	NSYTBS292412T	194
NSYTBP19128T	195	NSYTBS292416H	194
NSYTBP191610H	195	NSYTBS29248	194
NSYTBP19168	195	NSYTBS342912	194
NSYTBP241910H	195	NSYTBS342916H	194
NSYTBP241910HT	195	NSYTBS775	194
NSYTBP241912H	195	NSYTBS885	194
NSYTBP24198	195	P223H-3A	39

Alphanumeric Index

Cat No	Page
P300ALED-BK	39
P300ALED-B-XW	39
P300KBC-BK	39
P300KBC-XW	39
P300PBC-BK	39
P300PBC-XW	39
P331GC-XW	34
P332GC-XW	34
P333GC-XW	34
P334GC-XW	34
P335GC-XW	34
P336GC-XW	34
P343H-XW	39
P350VH-BK	33
P350VH-XW	33
P361-BK	33
P361-XW	33
P362-BK	33
P362-XW	33
P380A20DPC-K-XW	37
P380A32HOB-XW	39
P380A32RANGE-XW	39
P380AFRIDGE-XW	37
P380ALR-XW	37
P380ALRSENSR-XW	37
P380AR32-BK	37
P380AR32-XW	37
P380M20DP	37
P380M32HOB-XW	37
P380M32O-XW	37
P381-XW	33
P381ADISHWSR-XW	39
P381AFAN-XW	37
P381AFRIDGE-XW	37
P381AHEAT-XW	37
P381ALIGHT-XW	37
P381ALR-BK	39

Cat No	Page
P381ALR-XW	39
P381AMICROW-XW	39
P381AR-BK	37
P381AR-XW	37
P381ASENSOR-XW	37
P381AWASTE-XW	39
P381C-BK	34
P381C-XW	34
P381G	33
P381M10PM-XW	37
P381PAM-XW	39
P381PDY-XW	39
P381PHW-XW	39
P381POF-XW	39
P381VWP-XW	33
P382-XW	33
P382C-BK	34
P382C-XW	34
P382G	33
P382VWP-XW	33
P383-XW	33
P383C-BK	34
P383C-XW	34
P383G	33
P383VWP-XW	33
P384-XW	33
P384C-BK	34
P384C-XW	34
P384G	33
P385C-BK	34
P385C-XW	34
P385G	33
P386C-BK	34
P386C-XW	34
P387A012-XW	39
P387A4R2-BK	39
P387A4R3-BK	39

Alphanumeric Index

Cat No	Page
P387AOM-XW	39
P387ASON-XW	39
P387AUOD-XW	39
P387M3T-XW	37
P387M3T-XW	37
P387M3TM-XW	37
P387M4R2-XW	37
P387M4R3-XW	37
P391-15-XW	36
P391-15C-BK	36
P391-15C-XW	36
P391-15G	36
P391-XW	36
P391C-BK	36
P391C-XW	36
P391G	36
P391RCD30-XW	36
P392-XW	36
P392C-BK	36
P392C-DB	36
P392C-RD	36
P392C-XW	36
P392G	36
P392USB2-XW	36
P392X-XW	36
P392XC-BK	36
P392XC-XW	36
P392XG	36
P394-15-XW	34
P394-15C-BK	35
P394-15C-XW	35
P394-15G	35
P394-20-XW	34
P394-XW	34
P394C-BK	35
P394C-XW	35
P394G	35

Cat No	Page
P394X-XW	34
P394XC-BK	35
P394XC-XW	35
P394XG	35
P395-15-XW	34
P395-15C-XW	36
P395-15G	35
P395-XW	34
P395C-BK	35
P395C-DB	35
P395C-RD	35
P395C-XW	35
P395G	35
P395H4-XW	34
P395H4C-BK	35
P395H4C-XW	35
P395H4G	35
P395H4XXUA-XW	34
P395H4XXUAC-BK	35
P395H4XXUAG	35
P395PI-XW	34
P395PRCD-XW	34
P395R-XW	34
P395RC-BK	35
P395RC-XW	35
P395RCD30-XW	34
P395RG	35
P395USB2-XW	34
P395X-XW	34
P395XC-BK	35
P395XC-XW	35
P395XG	35
P3TOOL	39
P40CSFM-XW	37
PDL300USB2CAC-AN	9
PDL300USB2CAC-CY	9
PDL300USB2CAC-VW	9

Alphanumeric Index

Cat No	Page
PDL300USB2CAC-WY	9
PDL3S130GY	185
POAG-ID6	217
PS35	136
PS55	136
PS80	136
PS80F	136
PT80	136
R01	218
R5041NL	151
R5042NL	151
R5043NL	151
R5044NL	151
R5045EDLB-ZB	151
R5045EDLW-ZW	151
RJ45SMA6AC	144
RJ6AF/24PP	143
RJ6AU24PPC	143
S120EM	115
S132EM	115
S180BW	136
S180FW	136
S220EM	115
S280BW	136
S280FW	136
S300KBC-CE	26
S300KBC-SH	26
S300KBC-SV	26
S300PBC-SH	26
S300PBC-SV	26
S31LCDA	65
S320EM	115
S332EM	115
S340EM	115
S343C-CE	27
S343C-SH	27
S343C-SV	27

Cat No	Page
S347C-SH	27
S347C-SV	27
S380AR32-CE	26
S380AR32-SH	26
S380AR32-SV	26
S380BW	136
S380FW	136
S381AR-CE	26
S381AR-SH	26
S381AR-SV	26
S381C-CE	25
S381C-SH	25
S381C-SV	25
S382C-CE	25
S382C-SH	25
S382C-SV	25
S383C-CE	25
S383C-SH	25
S383C-SV	25
S384C-CE	25
S384C-SH	25
S384C-SV	25
S385C-CE	25
S385C-SH	25
S385C-SV	25
S386C-SH	25
S386C-SV	25
S387A4R-CE	26
S387A4R-SH	26
S387A4R-SV	26
S392C-CE	28
S392C-SH	28
S392C-SV	28
S392XC-CE	28
S392XC-SH	28
S392XC-SV	28
S394C-CE	29

Alphanumeric Index

Cat No	Page
S394C-SH	29
S394C-SV	29
S394XC-CE	29
S394XC-SH	29
S394XC-SV	29
S395C-CE	29
S395C-SH	29
S395C-SV	29
S395H4C-CE	29
S395H4C-SH	29
S395H4C-SV	29
S395H4XXC-SH	29
S395H4XXC-SV	29
S395XC-CE	29
S395XC-SH	29
S395XC-SV	29
SAE_UE_MS_1R_WE	125
SAE_UE_MS_CDBWE	125
SAE_UE_MS_CSAWE	125
SC5000CTL2-WE	151
SE2	111
SE2	129
SE4	111
SE4	129
SIGN/CPA	218
SNZ5424010CUT	146
SNZ5428377	146
SS15/15	108
U1	188
U1S	188
U2	188
U2S	188
U2T	188
U3	188
U4T	188
U6T	188
USBC-CAPS	85

Cat No	Page
VDIB17346UWE	144
VDIB1734XUWE	144
VDIB17366UWE	144
VDIB1736XUWE	144
VDIB17386UTN	144
VDIB1738XUTN	144
VDIB17396UTN	144
VDIB1771XB12	147
VDIB177AXB10TN	147
VDIB177AXU10TN	147
VDIB27730MWE	147
VDICD68X218	147
VDIG011241F	147
VDIG321241B	147
WDL10	114
WDL10	121
WE1GY	114
WE1SGY	114
WE2GY	114
WE2SGY	114
WHA120	116
WHB120	116
WHB140	116
WHB320	116
WHB340	116
WHB420	116
WHC363/40	116
WHC380	116
WHC480	116
WJ1GY	114
WJ2GY	114
WMB310	192
WMB315	192
WMB320	192
WMB332	192
WMB332R	192
WMB410	192

Alphanumeric Index

Cat No	Page
WMB420	192
WMB432	192
WMB432R	192
WMB463	192
WMB510	192
WMB520	192
WMB532	192
WMB532R	192
WMB563R	192
WMC310	191
WMC315	191
WMC320	191
WMC332	191
WMC410	191
WMC420	191
WMC432	191
WMC450	191
WMC463	191
WMC510	191
WMC550	192
WMC563	192
WMBJ1	192
WMS110	191
WMS110-TW	191
WMS116	191
WMS120	191
WMS210	191
WMS310	191
WMS3100	191
WMS3125	191
WMS320	191
WMS332	191
WMS340	191
WMS350	191
WMS363	191
WMS380	191
WS226	116

Cat No	Page
WS226/2	116
WS226/20	116
WS226/2PB	116
WS226D	116
WS226I	116
WS226PB	116
WS229	116
WS229VH	116
WSC227	117
WSC227/1	117
WSC227/1/15	117
WSC227/15	117
WSC227/2	117
WSC227/2/15	117
WSC227/2X	117
WSC227F1	117
WSC227F2	117
WSC228	117
WSCF227/1	117
WSCF227/2	117
WSCF227F2	117
WSCF228	117
WSF226	116
WSF226/2	116
WSF226/3	116
WSO310/2LEGY	114
WSO310LEGY	114
WSO310XLEGY	114
WSO315LEGY	114
WSR226	117
WSW201LEGY	114
WSW202LEGY	114
WSW321LEGY	114
Z4015	66
Z4015L	66
Z4025	66
Z4025H2	66

Alphanumeric Index

Cat No	Page
Z4025USBC	66
Z4025XA	66
Z4025XUA	66
Z4031VH-ZW	66
Z4032HS-ZW	66
Z4032HSUSBC-ZW	66
Z4032VH-ZW	66
Z4033VH-ZW	66
Z4034VH-ZW	66
Z4036VH-ZW	66
Z4060CSFM	65
Z4060VX	64
Z4061	64
Z4061AL	64
Z4061D32	65
Z4061PBL	64
Z4061VH	64
Z4062	64
Z4062AL	64
Z4062EDIM-KB	65
Z4062PBL	64
Z4062VH	64
Z4063PBL	64
Z4063VH	64
Z4064VH	64
Z4065VH	64
Z4066VH	64

All enquiries

Email: customercare.nz@schneider-electric.com

Website: pdl.co.nz

Tel: 0800 652 999

Fax: 0800 101 152

Main office locations

Auckland head office

Address Level 2, Building 6, 60 Highbrook Drive Highbrook, Auckland 2013

Tel +64 9 829 0490

Fax +64 9 829 0491

Postal address PO Box 259370, Botany, Manukau 2163, Auckland, New Zealand

Napier

Address 2/82 Austin Street, Onekawa 4110

Tel +64 6 843 5855

Christchurch

Address Level 2, 4 Hazeldean Road, Addington, Christchurch 8024

Tel +64 3 338 9059

Fax +64 3 338 9842

Postal address PO Box 1367, Addington, Christchurch 8140

Life Is On



by **Schneider** Electric

For more information visit pdl.co.nz

Schneider Electric (NZ) Ltd.
Level 2, Building 6
60 Highbrook Drive, East Tamaki
Manukau 2013
Tel: +64 9 829 0490
Fax: +64 9 829 0491
se.com/nz
pdl.co.nz

Customer Care
Tel: 0800 652 999
Email: customercare.nz@schneider-electric.com